



Newland

SCANNING MADE SIMPLE



NQuire 350 Skate micro kiosk user guide

Disclaimer

© 2020-2021 Newland Auto-ID Tech. Co., Ltd. All rights reserved.

Please read through the manual carefully before using the product and operate it according to the manual. It is advised that you should keep this manual for future reference.

Do not disassemble the device or remove the seal label from the device, doing so will void the product warranty provided by Newland Auto-ID Tech. Co., Ltd.

All pictures in this manual are for reference only and actual product may differ. Regarding to the product modification and update, Newland Auto-ID Tech. Co., Ltd. reserves the right to make changes to any software or hardware to improve reliability, function, or design at any time without notice. The information contained herein is subject to change without prior notice.

The products depicted in this manual may include software copyrighted by Newland Auto-ID Tech. Co., Ltd or third party. The user, corporation or individual, shall not duplicate, in whole or in part, distribute, modify, decompile, disassemble, decode, reverse engineer, rent, transfer or sublicense such software without prior written consent from the copyright holders.

This manual is copyrighted. No part of this publication may be reproduced, distributed or used in any form without written permission from Newland.

Newland Auto-ID Tech. Co., Ltd. reserves the right to make final interpretation of the statement above.

Newland Auto-ID Tech. Co., Ltd.

No.1, Rujiang West Rd., Mawei, Fuzhou, Fujian, China 350015

[Http://www.newlandaidc.com](http://www.newlandaidc.com)

Revision History

Version	Description	Date
V1.0.0	Initial release.	March.17 th , 2020
V1.0.1	Update the NQuire's default IP address	June.9 th , 2020
V1.0.2	Add system update methods.	July.1 st ,2020

Table of Contents

Revision History	- 3 -
Chapter 1 About This Guide.....	1
Introduction	1
Chapter Descriptions	1
Chapter 2 Getting Started.....	2
Introduction to the NQuire350.....	2
Unpacking	2
Product Outline	4
LEDs on the NQuire	4
Work Procedure	5
Mounting.....	5
Wiring	6
Physical Ports on the NQuire	6
Wiring Instructions	6
Installing the Micro SD Card	8
Enabling MTP.....	8
Chapter 3 Basic	10
Home Screen	10
Change wallpaper.....	10
Add Widgets	12
System Bar.....	14
Navigation Buttons.....	14
Status Notifications	15
Applications.....	16
Language & Input Method.....	17
Date & Time	18
Volume	19
Brightness	20
Schedule Power On/Off	21
Wi-Fi	23
Ethernet.....	24
Bluetooth	25
Virtual Keyboard.....	26
Surf Online	28
Play Media	29

Reset to Factory Default	30
Chapter 4 Configuring the NQuire.....	32
Introduction	32
Configuring the NQuire with the Web-based Tool	32
Network Settings.....	33
Messages Settings	35
Scanner Settings	37
Miscellaneous Settings.....	41
Log Settings.....	44
Backup.....	45
Time	46
Update	47
Reboot	48
Configuring the NQuire with Programming Barcodes	49
Enter/Exit the Setup Mode.....	49
Enable/Disable DHCP	49
Screen Brightness	50
Scanner Sensitivity	50
Beeper	51
Reboot	51
Return to Desktop.....	51
Query Configuration.....	52
Customizing Configuration Barcodes	52
Chapter 5 Using the NQuire	54
Introduction	54
Scanning Barcodes with NQuire 350.....	54
Reading RFID Tags.....	55
GPIO Device	56
Chapter 6 ESC Commands.....	59
Introduction	59
Text Display.....	59
NQuire Command Set.....	60
Examples.....	63
Chapter 7 System Update.....	65
Introduction	65
Updating System with a USB Flash Drive	65

Updating System via FTP	66
Updating System via System Update app	70
Online Update	70
Local Update.....	71
Chapter 8 ADB Debug	74
Introduction	74
Using the ADB.....	74
Chapter 9 Using an External Barcode Scanner	78
Introduction	78
Connecting a Barcode Scanner to the NQuire	78
Configuring an External Barcode Scanner	78
Configuring NLS-HR11 Plus	79
Chapter 10 Maintenance& Troubleshooting.....	80
Maintenance.....	80
Keeping the NQuire Dust-free	80
Cleaning.....	80
Troubleshooting.....	81
Chapter 11 Safety Information	82
Electrical Safety	82
Electromagnetic Compatibility	82
Eye Safety.....	84
Others.....	84
Appendix	85
Sample Barcodes.....	85
Code ID Table	86

Chapter 1 About This Guide

Introduction

This guide provides instructions for installing, programming and operating the NLS-NQuire350 series customer information terminal (hereinafter referred to as “**the NQuire**” or “**the terminal**”).

Chapter Descriptions

- ✧ *Chapter 1 About This Guide* Provides general description of this manual.
- ✧ *Chapter 2 Getting Started* Provides information on getting the NQuire up and running for the first time.
- ✧ *Chapter 3 Basic* Describes how to program the NQuire for the use of its basic features
- ✧ *Chapter 4 Configuring the NQuire* Describe how to program the NQuire with a web-based tool and with barcodes.
- ✧ *Chapter 5 Using the NQuire* Explains how to scan barcodes, read RFID tags and use a GPIO device.
- ✧ *Chapter 6 ESC Commands* Explains how to control the NQuire with ESC commands.
- ✧ *Chapter 7 System Update* Introduces two methods to update system.
- ✧ *Chapter 8 ADB Debug* Describes how to use the ADB tool.
- ✧ *Chapter 9 Using an External Barcode Scanner* Describes how to configure an external handheld barcode scanner to work with the NQuire.
- ✧ *Chapter 10 Maintenance & Troubleshooting* Provides maintenance tips and troubleshooting solutions for issues that might occur when using the NQuire.
- ✧ *Chapter 11 Safety Information* Provides safety instructions for the use of the NQuire and its accessories.
- ✧ *Appendix* Provides some sample barcodes for the user to test the NQuire.

Chapter 2 Getting Started

Introduction to the NQuire350

The NQuire 350 is designed to read/scan, inform and interact with your customer.

This small and attractive information terminal reads multiple data carriers; from 1D barcodes (such as EAN/UPC) to complex 2D barcodes displayed on mobile phones. It also comes with RFID reading capabilities.

The NQuire complies with the specifications of standard VESA 75 bracket, enabling easy mounting on shelves and walls. Furthermore, it is possible to add USB or Bluetooth peripherals to expand this solution with a printer, a handheld scanner for scanning large or bulky items, a magnetic stripe card reader and more.

The NQuire supports 10/100Mbps Ethernet, Wifi 802.11b/g/n and Bluetooth 4.0 LE and Power-over-Ethernet, so it can be easily integrated into your existing wireless or wired LAN.

The NQuire can be used for various applications such as Price Check, Inventory Check, Informational Product Videos, Gift Card/Coupon Lookup, Guided Selling, Digital Advertising/Signage, Call for Assistance, Store Maps and more.

Unpacking

Carefully remove all protective material from the pack and verify that the following items are present:

- ✧ NQuire350 x1



-
- ✧ Power adapter x 1, plug x 5



- ✧ VESA 75 mount x1, screwdriver x 1, port cover x 2



- ✧ Plastic wall anchor x 4, GPIO connector x 4, small screw x 6, large screw x 4



- ✧ Quick Start Guide x 1

Product Outline

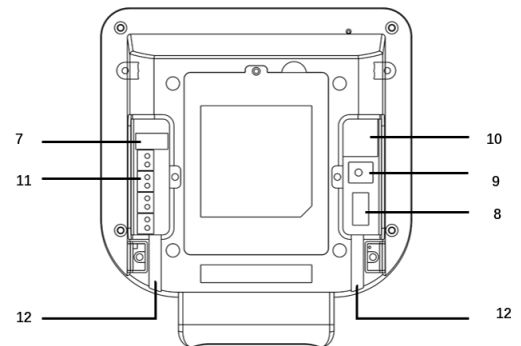
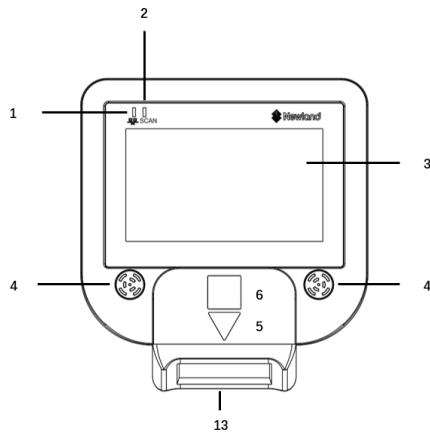

1	Network LED	2	Good Read LED
3	LCD (Touch) Display	4	Speaker
5	“Where to Scan Barcode” Arrow	6	RFID Antenna
7	USB Host/Slave Port	8	USB Host Port
9	Power Jack	10	Ethernet Port
11	GPIO Connectors	12	Cable Trough
13	Barcode Scanner		

LEDs on the NQuire

Network LED	
Blue LED on	Wi-Fi/Ethernet/Bluetooth is available
Good Read LED	
Green LED flashes once	A barcode has been scanned and decoded.

Work Procedure

1. The NQuire receives its input via:
 - ✧ 1D/2D barcode scan engine
 - ✧ RFID reader.
2. The NQuire sends the input to application program which runs on a remote PC or server.
3. Application program sends information back to the terminal for display.

Mounting

The NQuire comes standard with a VESA 75 mount. The VESA 75 mount consists of a bracket and a chassis. Please follow the instructions below to mount the NQuire onto the VESA 75 mount.

Step 1: Select a mounting location that is convenient for operation.

Step 2: For wall mounting, install the four plastic expansion anchors in a wall and then secure the bracket of VESA 75 mount to the wall using the four large screws. For countertop/shelf mounting, secure the bracket of VESA 75 mount to a countertop/shelf using the four large screws.

Step 3: Attach the chassis of VESA 75 mount to the back of the NQuire using the four small screws.

Step 4: Follow the instructions in the following “Wiring” section to complete the cable connections. Then slide the NQuire into the bracket.

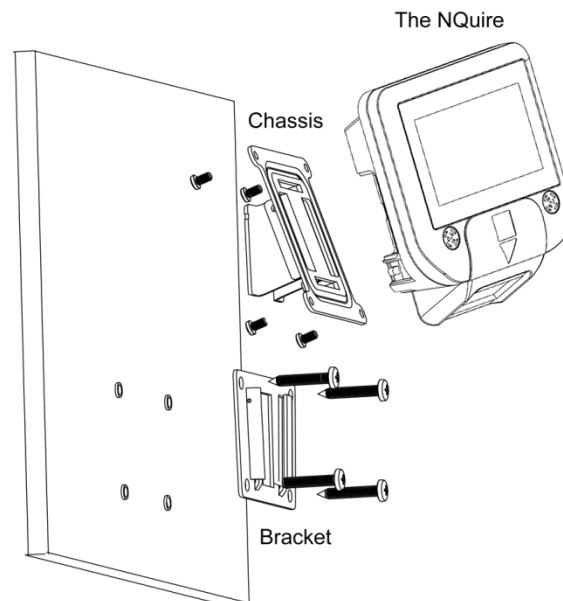

Wiring

Physical Ports on the NQuire

✧ **Power jack:**

It uses the center pin for positive and the outer tab for ground.

Input power requirement: DC 12V, 2A

✧ **Ethernet port:**

PIN	Description
1	Tx_D1+
2	Tx_D1-
3	Rx_D2+
4	BI_D3+ / PoE
5	BI_D3- / PoE
6	Rx_D2-
7	BI_D4+ / PoE
8	BI_D4- / PoE

1 2 3 4 5 6 7 8

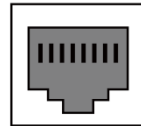

✧ **USB Host port:** It can be connected to a handheld barcode scanner, printer, magnetic stripe card reader or other external device.

✧ **GPIO connectors (General Purpose Input/Output interface):**

Two in (Each contains 2 pins); two out (Each contains 2 pins)

Wiring Instructions

Select one of the following power supply solutions and make the cable connections accordingly.

Power adapter solution

Step 1: Put the NQuire face down. Remove the port cover on the right.

Step 2: Attach the appropriate plug type to the power adapter and plug it into the power jack on the NQuire.

Step 3: Lead the cable through the cable trough for appropriate routing.

Step 4: Wired Ethernet: Connect an Ethernet cable to the Ethernet port on the NQuire, then install the port cover and fasten it with the screw.

Wireless Ethernet: Install the port cover and fasten it with the screw.

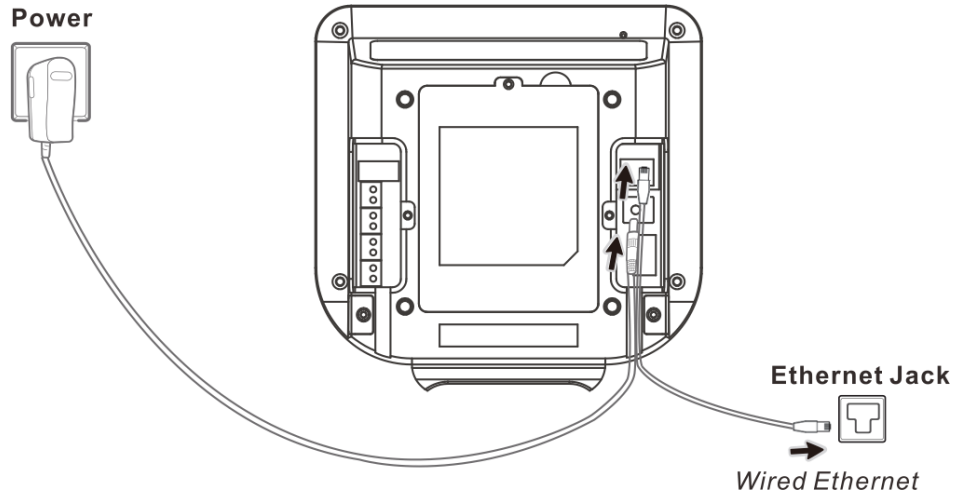

Power-over-Ethernet (PoE) solution

- Step 1: Put the NQire face down. Remove the port cover on the right.
- Step 2: Connect one end of an Ethernet cable to the Ethernet port on the NQire.
- Step 3: Lead the cable through the cable trough for appropriate routing.
- Step 4: Replace the port cover and fasten it with the screw.
- Step 5: Connect the other end of the Ethernet cable to a PoE power module or a PoE switch (NOT supplied by Newland). The NQire supports both the Mid-span and End-span PoE protocol.
- Step 6: Connect DC power to either the third-party PoE power module or PoE switch if required.

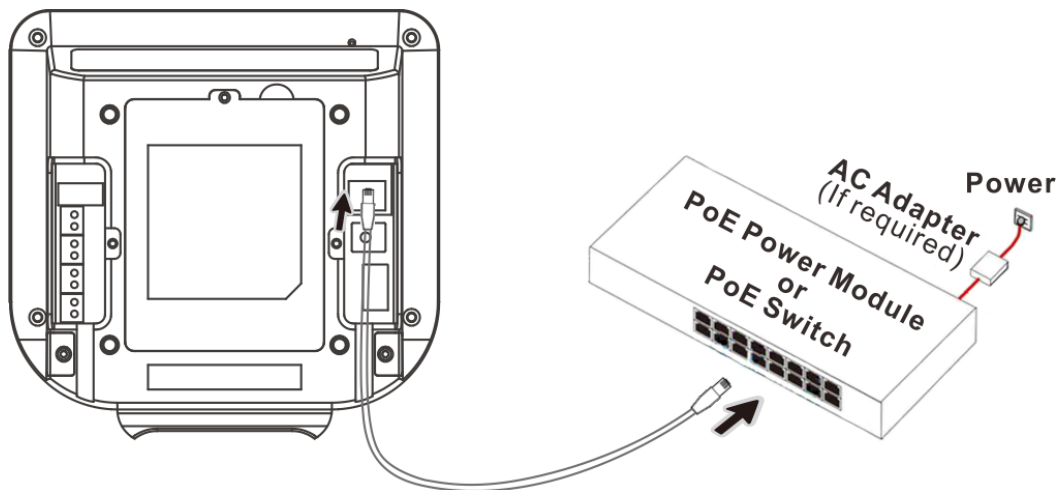

Note: Do not connect power adapter to the power jack on the NQire when adopting PoE solution. Otherwise there is a risk of damage to the NQire.

Installing the Micro SD Card

Step 1: Loosen the screw on the back cover of the NQuire and remove the back cover. Slide the slot cover rightward and lift the left end of it.

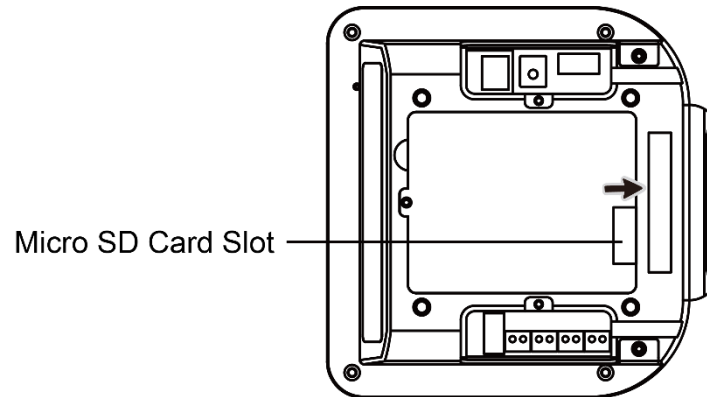

Step 2: Insert the Micro SD card into the slot, with its metal contacts facing down.

Step 3: Close the slot cover and slide it leftward until it clicks.

Step 4: Replace the back cover and fasten it with the screw removed in Step 1.

Enabling MTP

MTP (Media Transfer Protocol) lets you transfer files between your NQuire and a PC. To enable it, follow the steps below:

Step 1: Connect the USB Host/Slave port on the NQuire to PC with a USB cable (purchase separately).

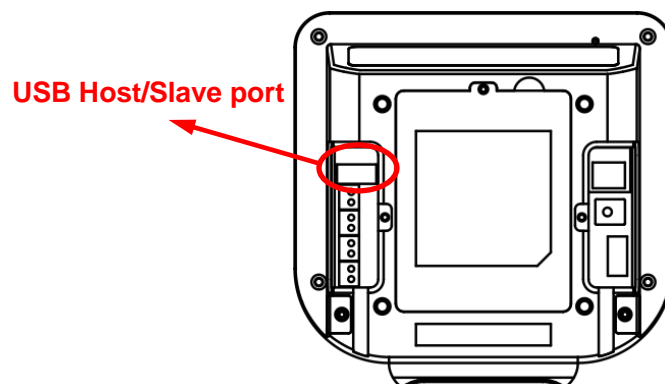

Step 2: Follow the steps described in the “Using the ADB” section in Chapter 8 to enable OTG. Then move down and find “USB debugging” and enable this function.

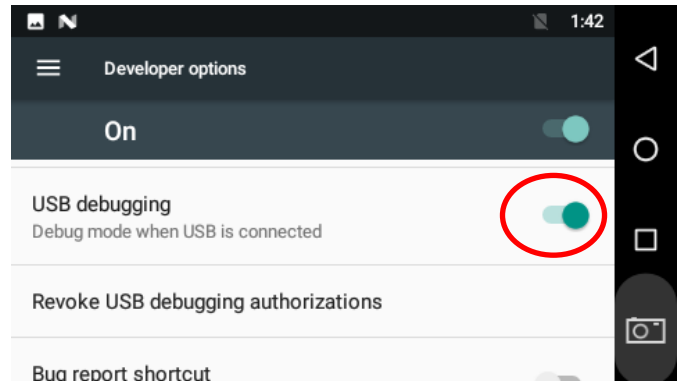
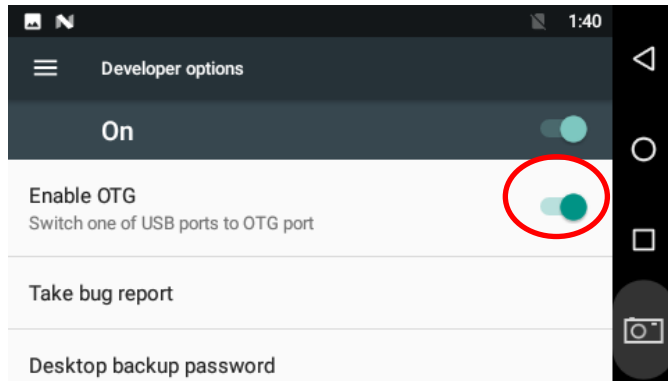

Step 3: Swipe down the screen and it will pop up the notification bar. Find the “USB for file transfer” and tap it, then select “Transfer files”.

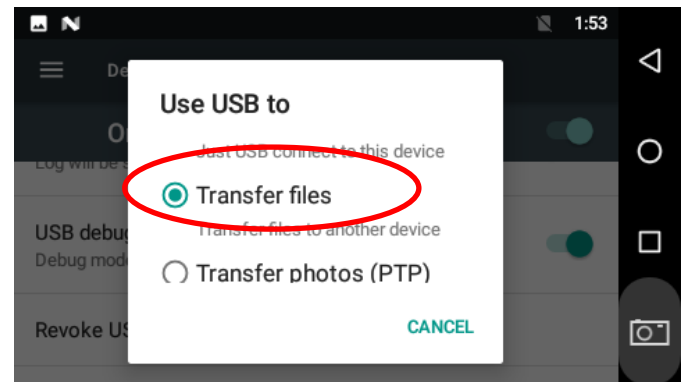
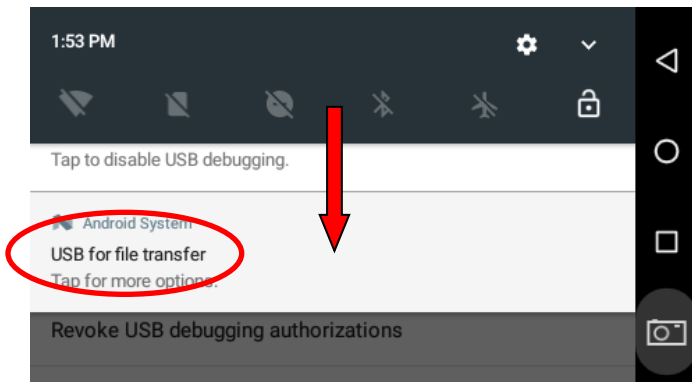

Chapter 3 Basic

Home Screen

On the home screen, you can long-tap on any blank area to change the wallpaper or drag widgets to desktop.

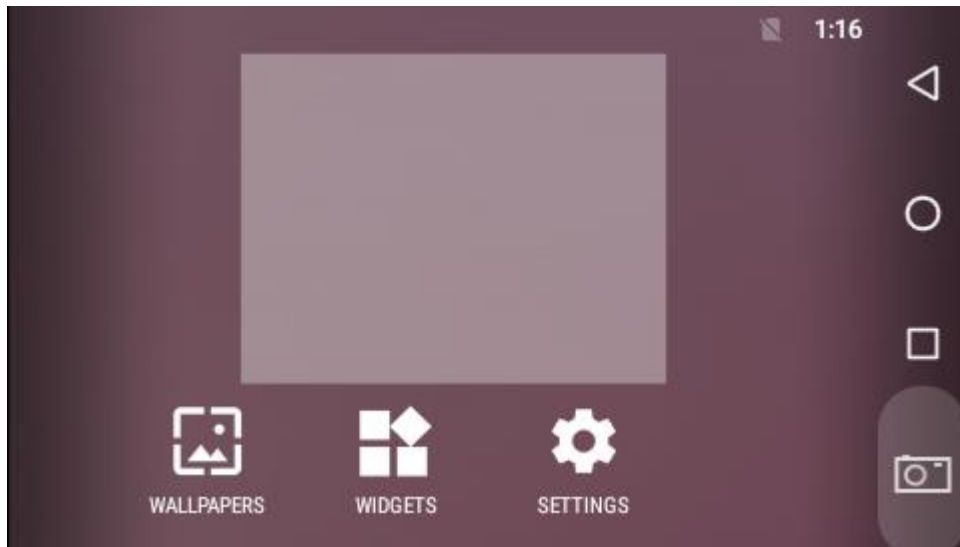

Change wallpaper

1. Tap  WALLPAPERS.

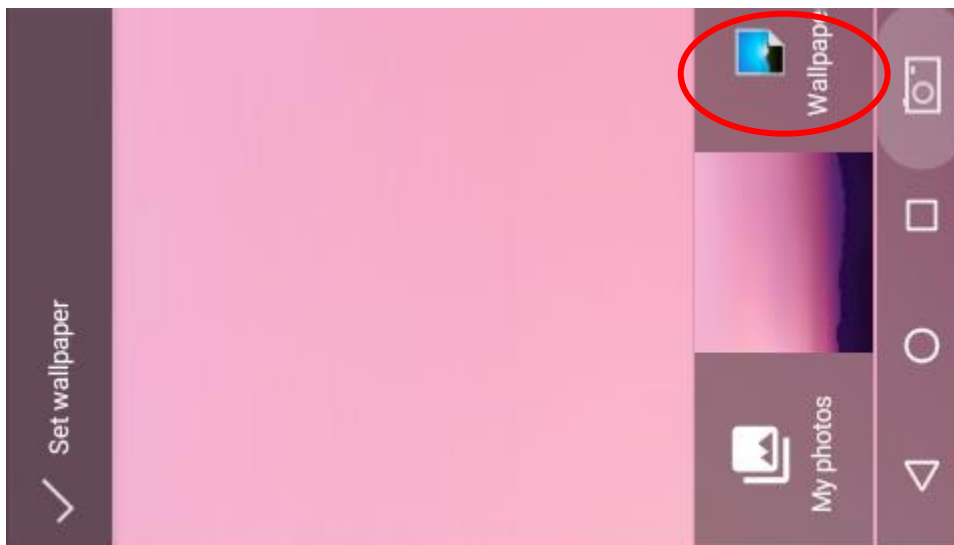

2. Tap **“Wallpapers”**. Select the image you want as your wallpaper.

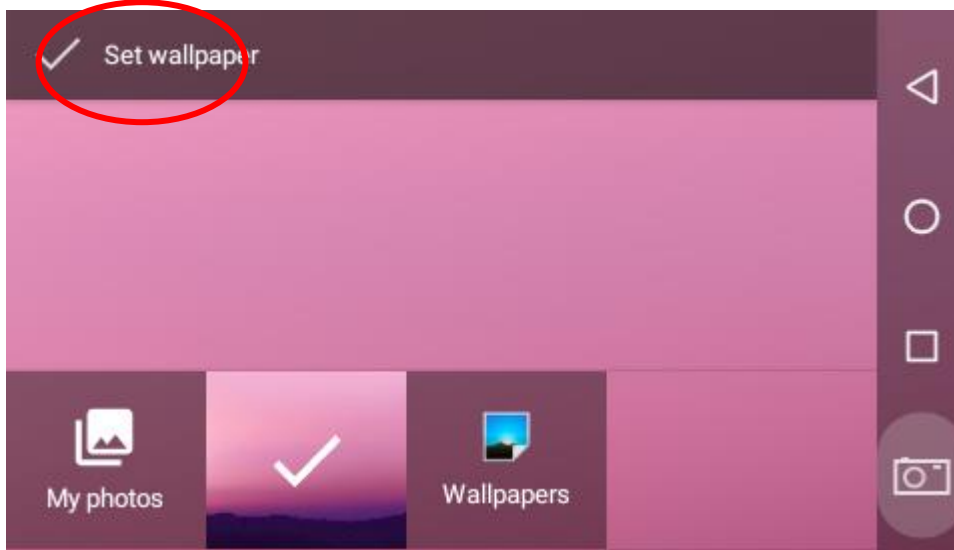

3. Tap **“Set wallpaper”** on the upper-left corner of the screen then **“Home screen”** to apply the new wallpaper.

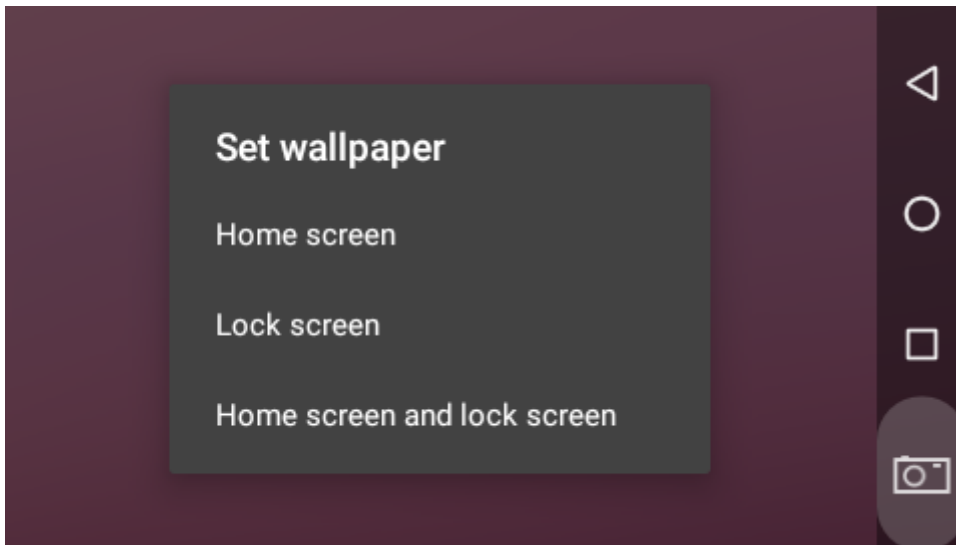

Add Widgets

1. Tap .

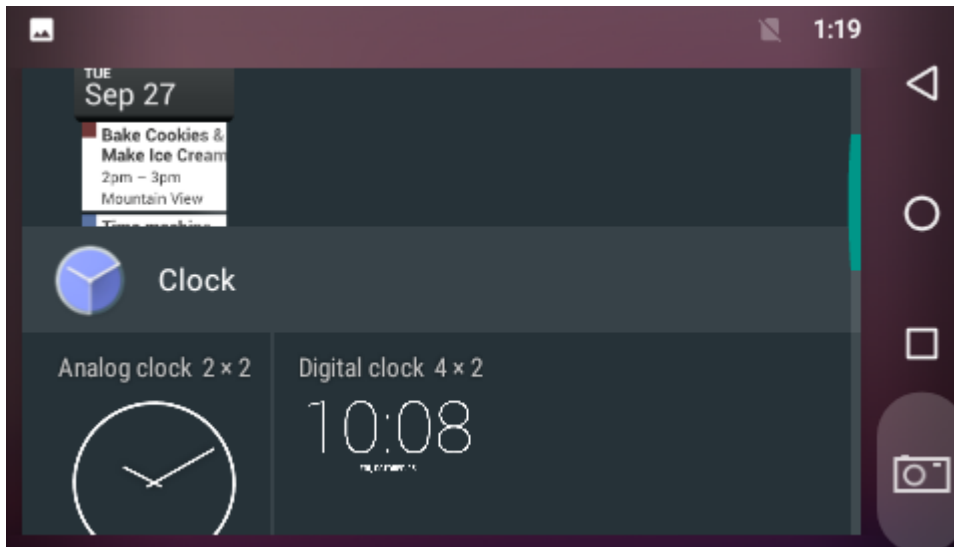

2. Long-tap on a widget and drag it to desktop.

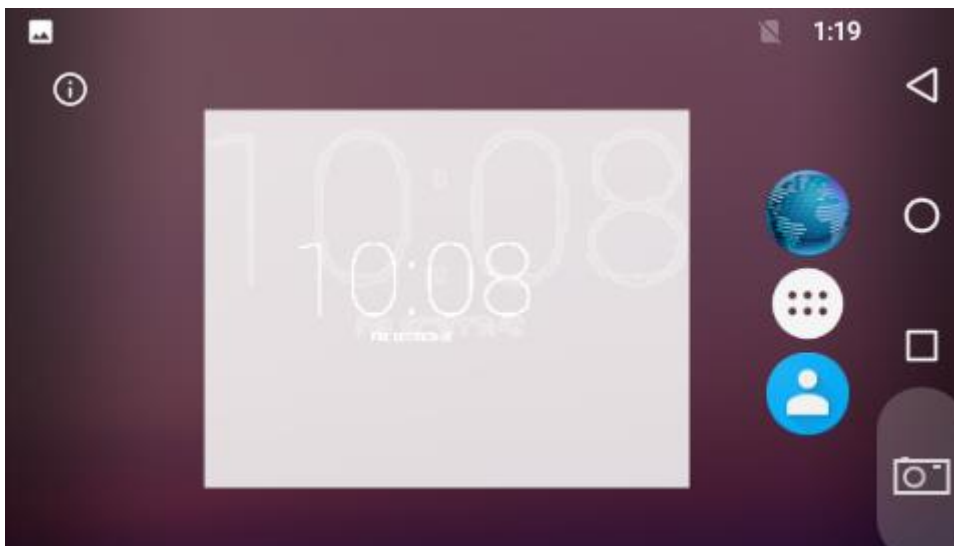

-
3. If you want to remove an icon, long-tap on the widget and then drag it onto “X” at the top of the screen.

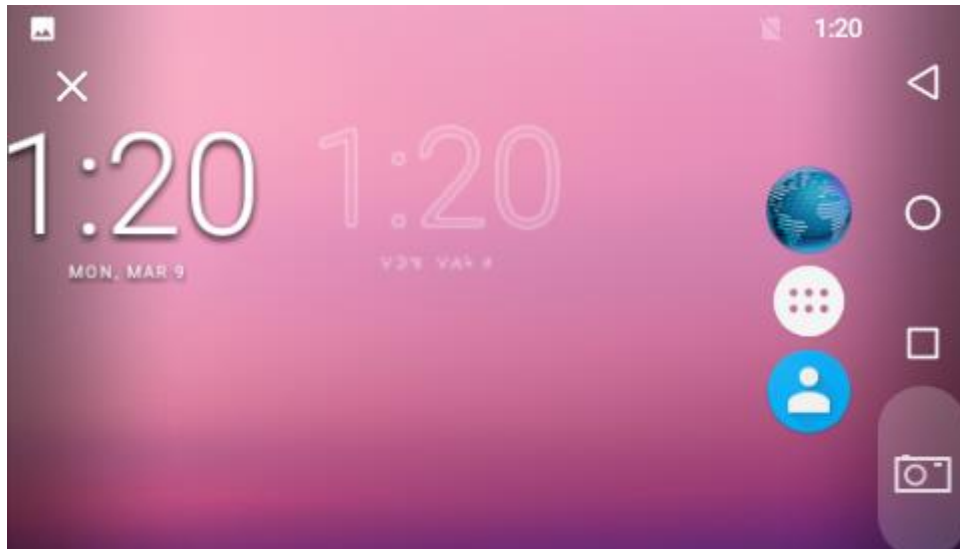

System Bar

Navigation Buttons

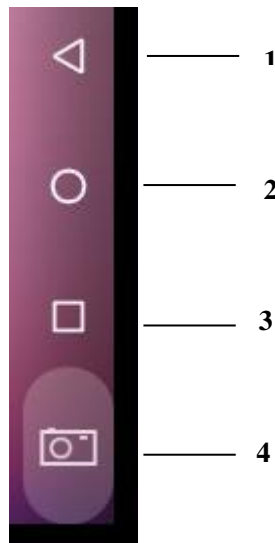

1. **Back:** Return to the previous page.
2. **Home:** Return to the home screen.
3. **Recents:** Switch between recently used apps.

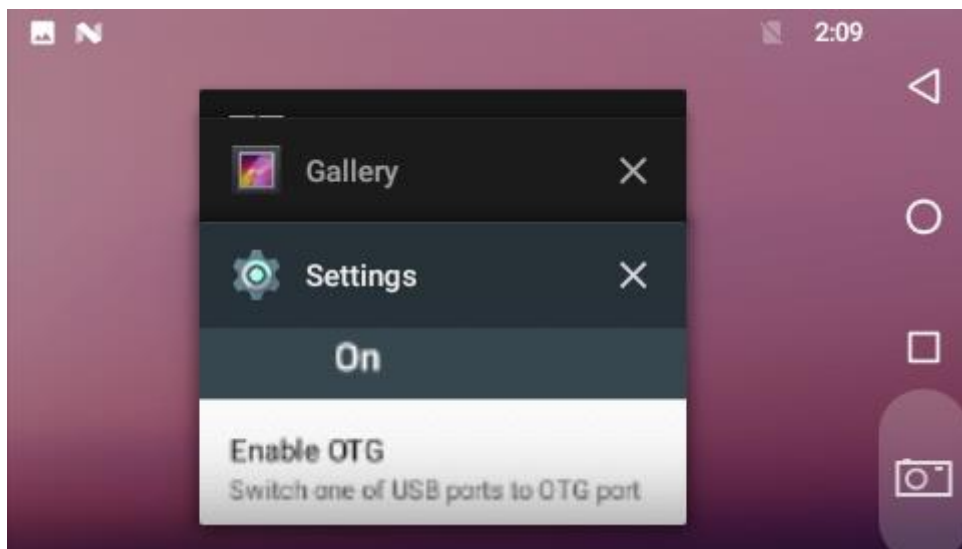

To remove an app from the list, swipe the app item left or right or tap “X” in the upper-right corner of the app window to remove it.

4. **Screenshot:** Take a screenshot.

Status Notifications



Status bar at the top of the screen displays system status, such as time, Wi-Fi, SIM card and USB connection, etc.

1. Pull down the status bar to open the status window.

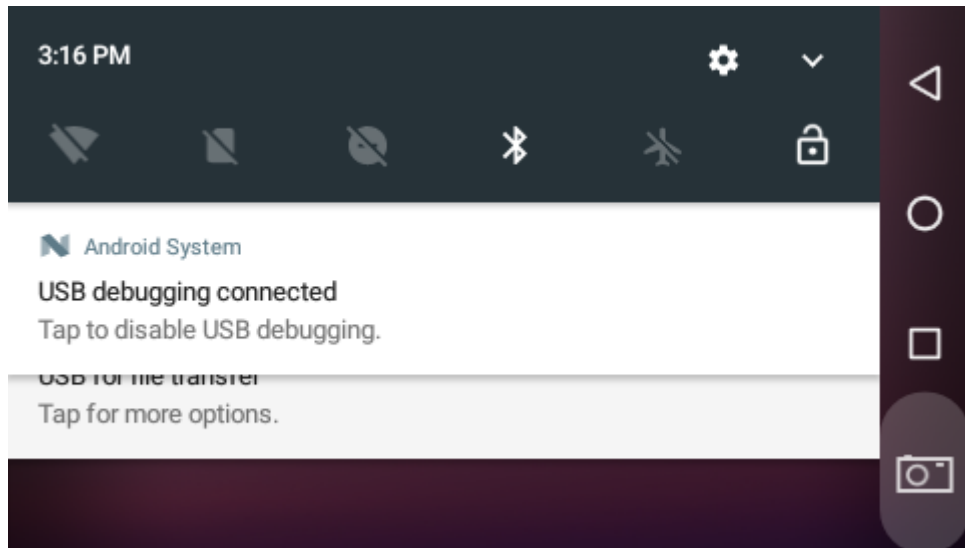

2. Pull down the status bar to open the shortcuts window which contains brightness adjustment, Wi-Fi, no SIM card, do not disturb, landscape, bluetooth, airplane mode, physical button and invert colors, and system settings entrance.

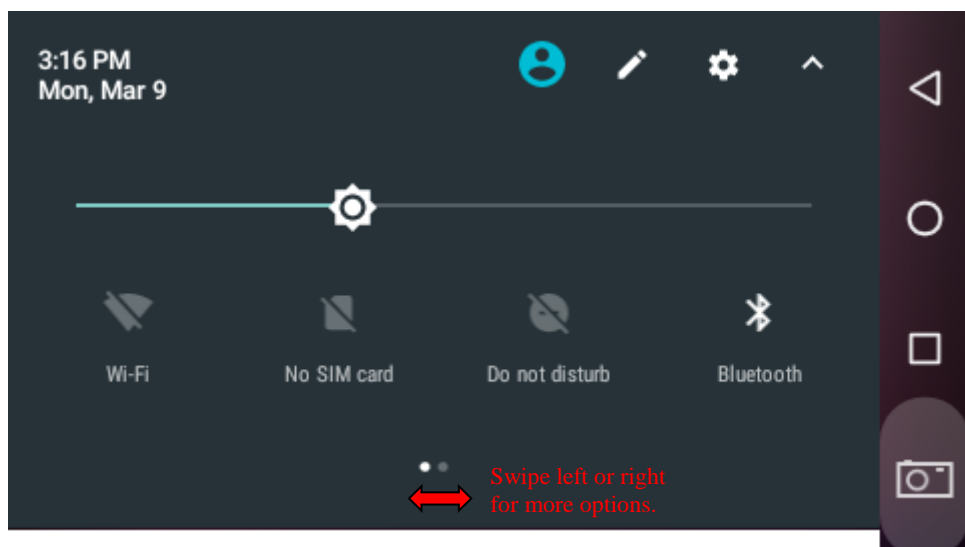

Applications

Tap  icon on the home screen to view the App list.

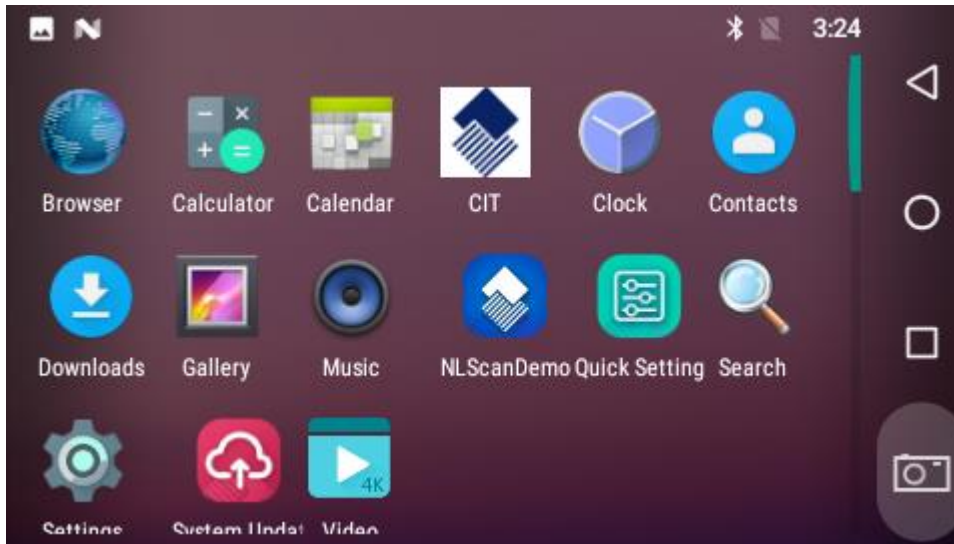

The installed applications will be shown here and you can open an app by tapping its icon. To find an app easily, you can create a shortcut by long-taping on the icon and dragging it into the home screen.

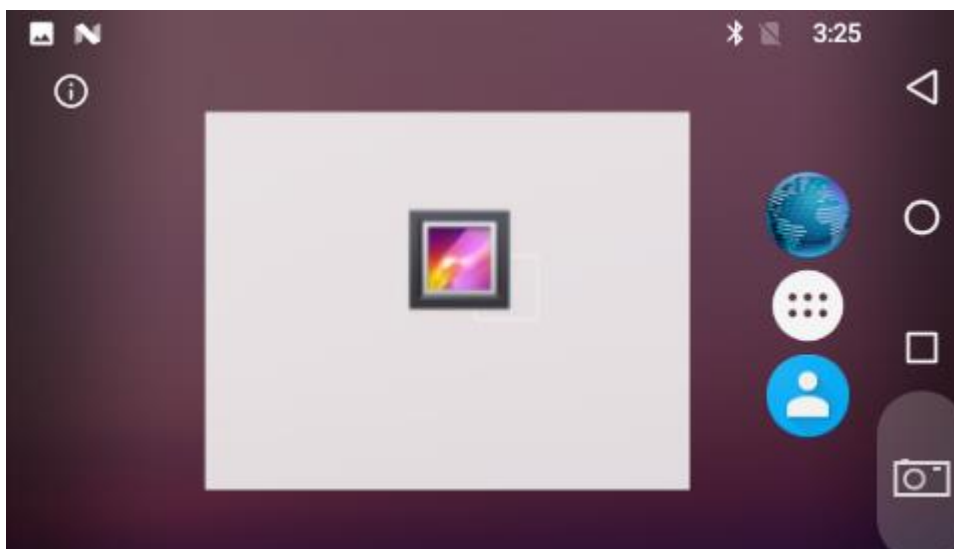

Language & Input Method

In the App list, tap **“Settings”**  to open the system settings app, and select **“Language & input”**.

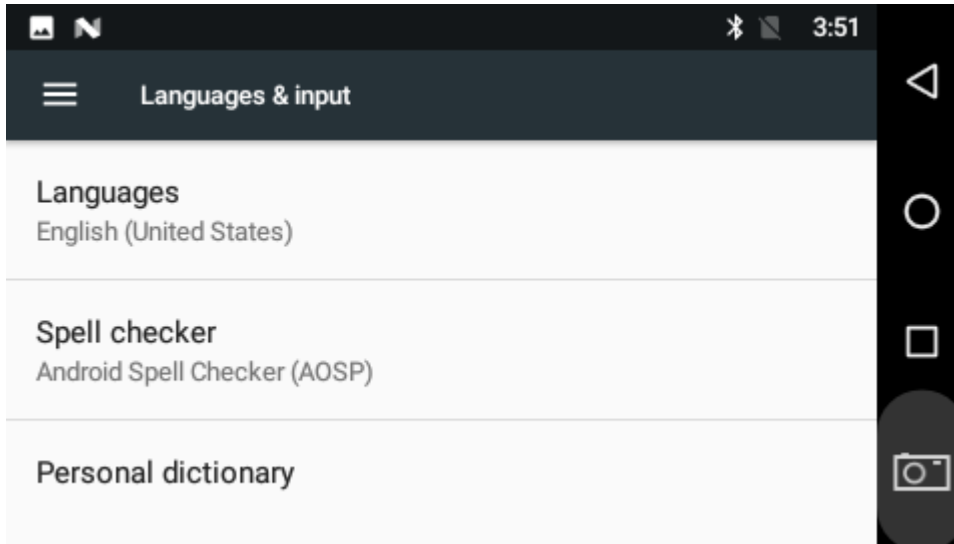

Change language: Tap **“Language”** then **“Add a language”**, and then you can change the system language according to your preference.

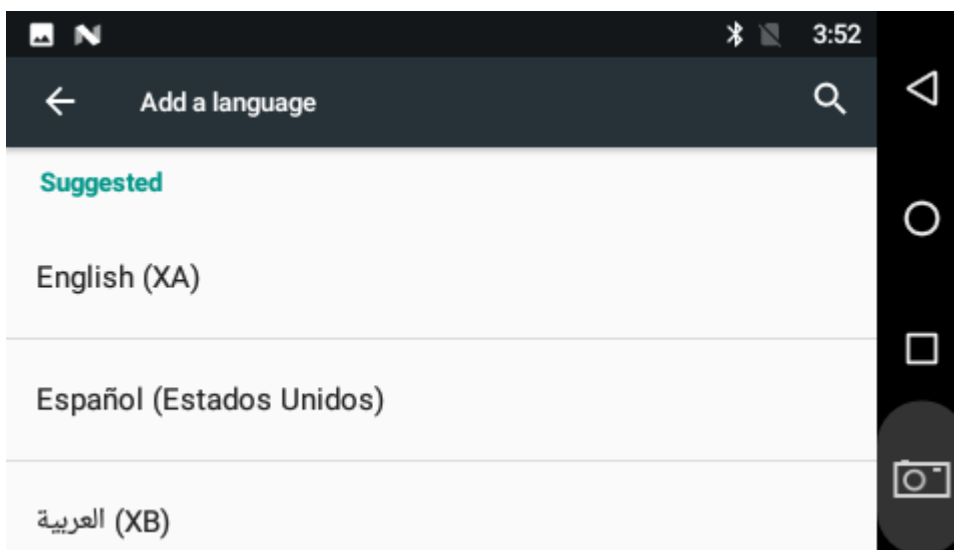

Enable an input method: Tap “**Virtual keyboard**” then “**Manage keyboards**”, and then enable the desired input method.

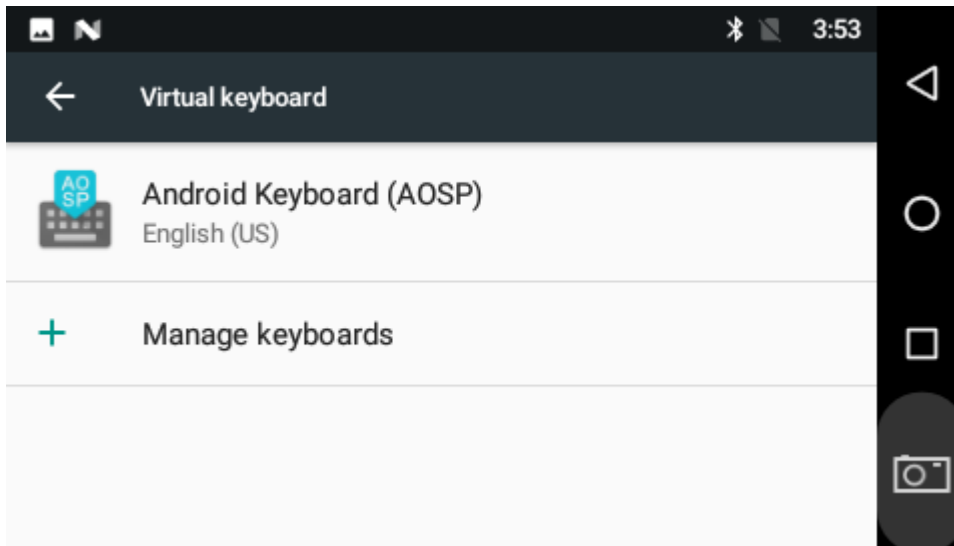

Date & Time

In the App list, tap “**Settings**”  to open the system settings app, and select “**Date & time**”.

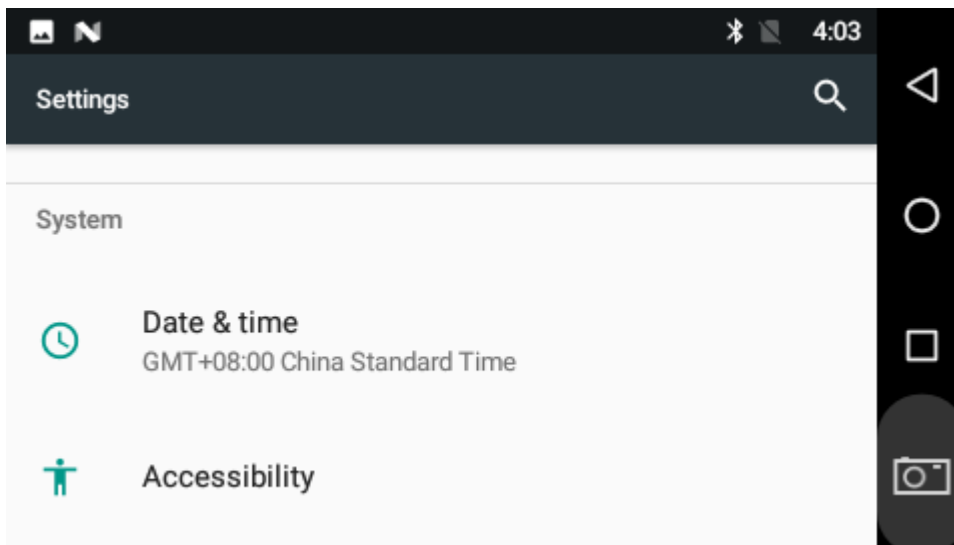

If the “**Automatic date & time**” option is enabled, system date and time will be synchronized automatically with network time when you connect your device to a Wi-Fi network.

To set the time manually, you need to disable “**Automatic date & time**” & **Automatic time zone**.

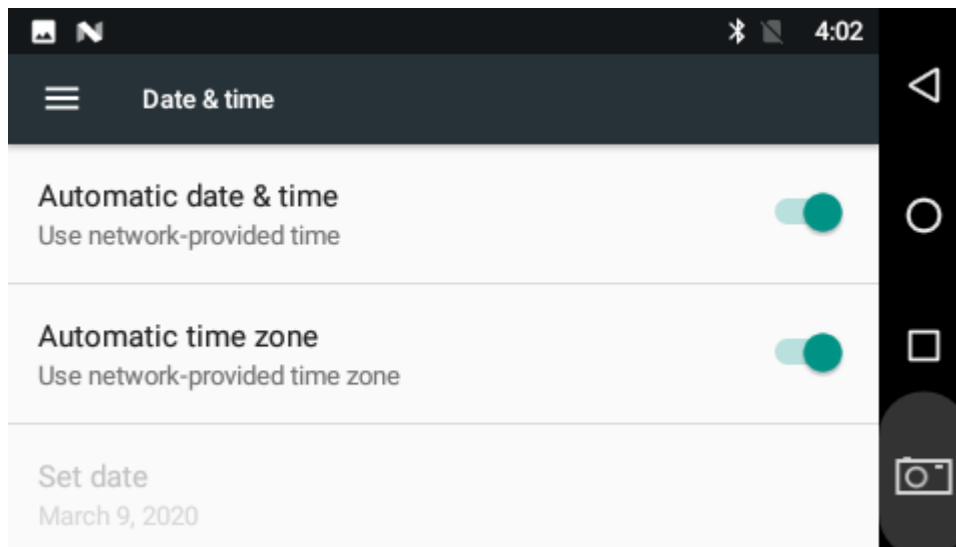

Besides, you can also set time zone and time format as per your needs.

Volume

In the App list, tap “**Settings**”  to open the system settings app, and select “Sound”. Then you can set the parameter per your need.

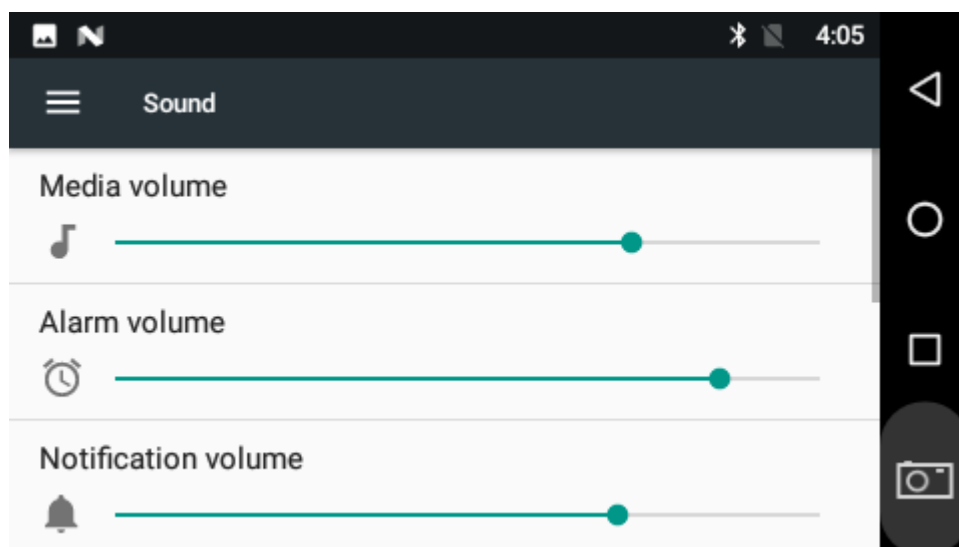

Brightness

In the App list, tap **“Settings”**  to open the system settings app, and select **“Display”**. Tap **“Brightness level”** and then move the brightness slider to the left to decrease the brightness and right to increase it.

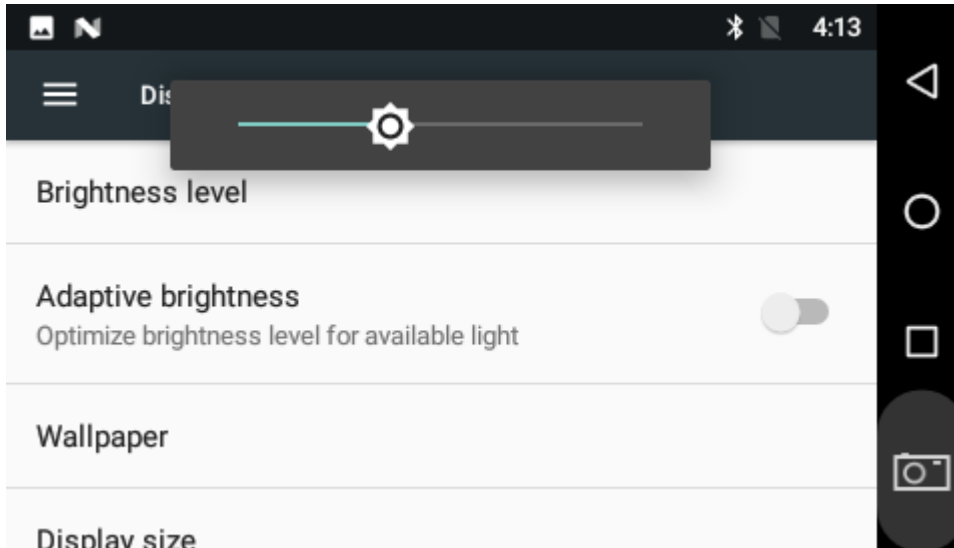

If you want the brightness to be adjusted automatically based on ambient lighting, enable the **“Adaptive brightness”** option.

Schedule Power On/Off

This function is used to power the device on and off automatically at a specific time each day.

In the App list, tap **“Settings”**  to open the system settings app, and select **“Time Screen”**.

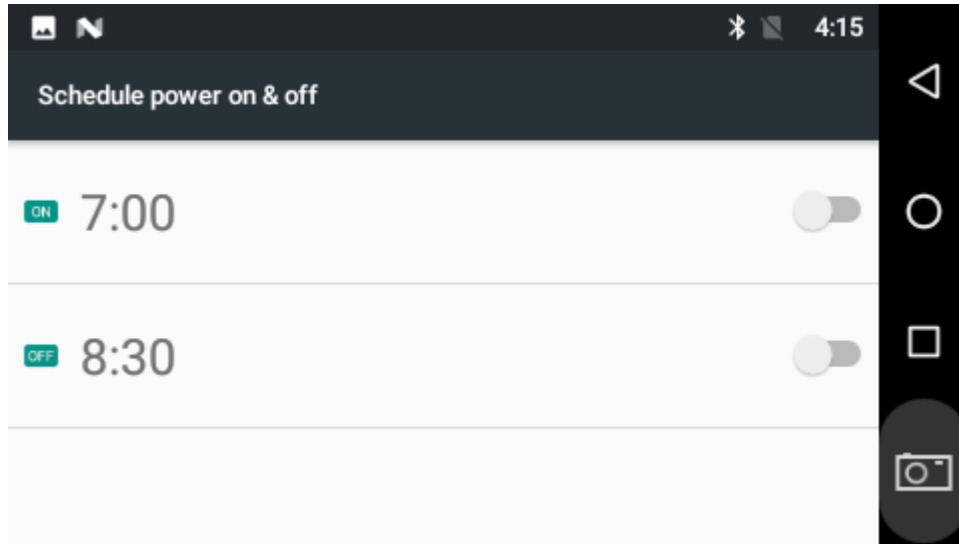

The top row is for power on clock, and the following row is for power off clock. To enter the power on/off clock settings, tap the corresponding row.

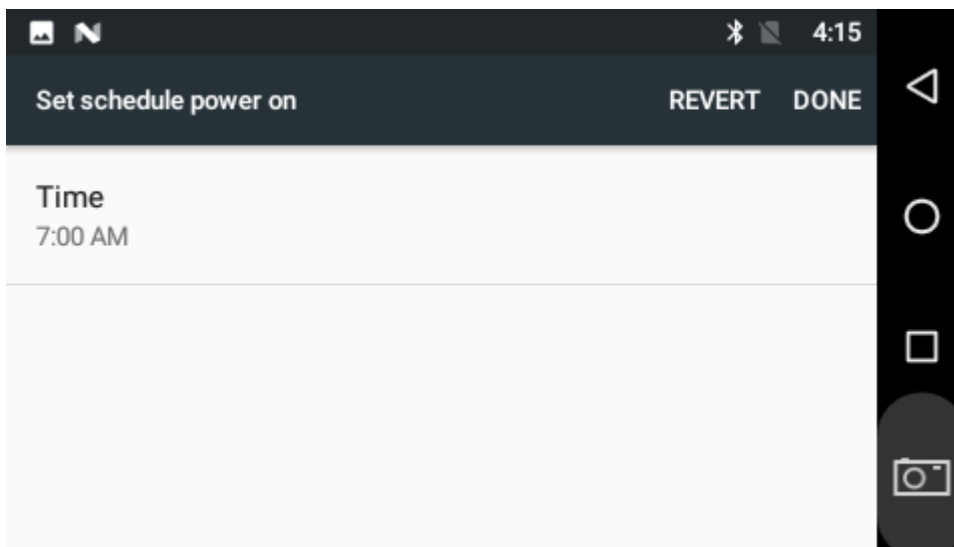

Tap **“Time”**. Then set the time and tap **“OK”**.

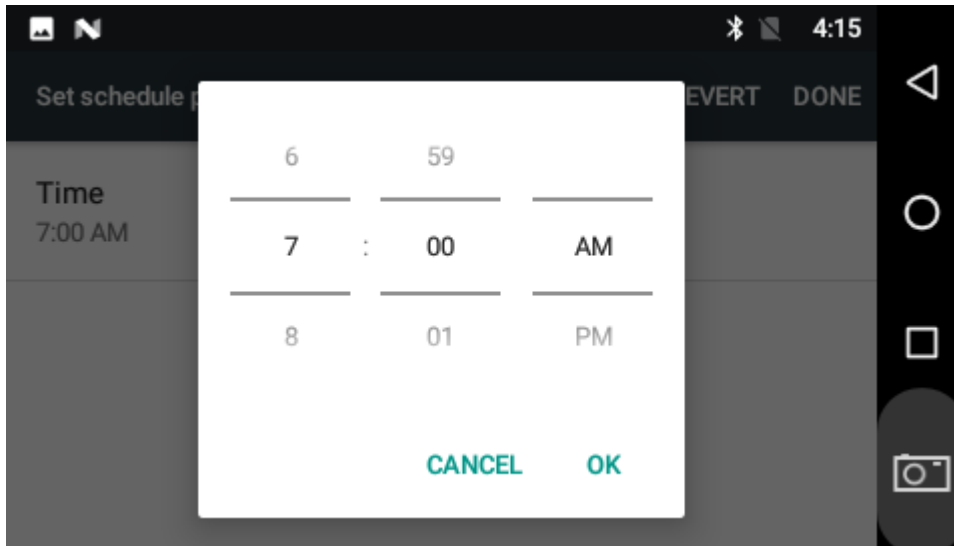

Tap **“DONE”** at the upper-right corner of the screen to save the setting.

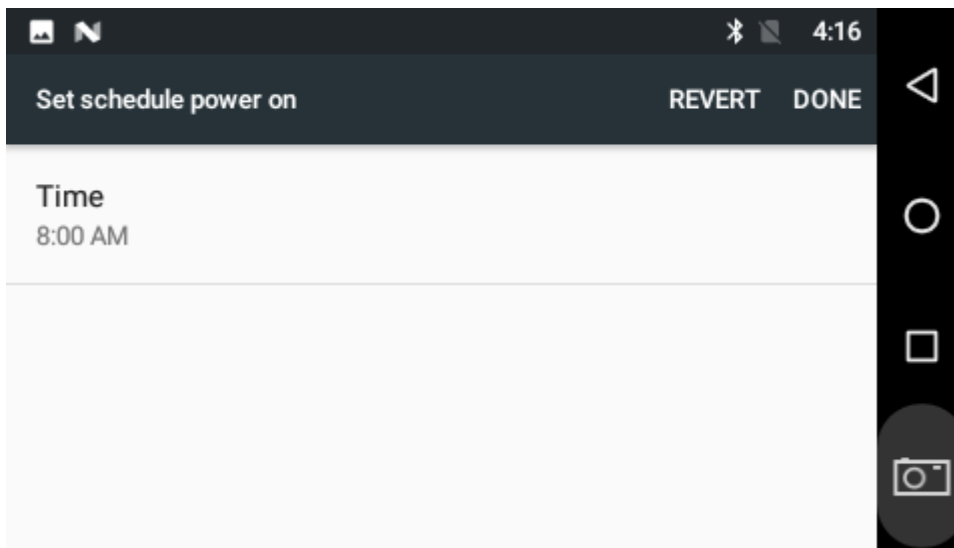

Wi-Fi

Join a Wi-Fi network: In App list, tap **“Settings”**  to open system settings app, and select **“Wi-Fi”**. Turn Wi-Fi on to find available Wi-Fi networks. Select a network and enter the password, then tap **“CONNECT”**.

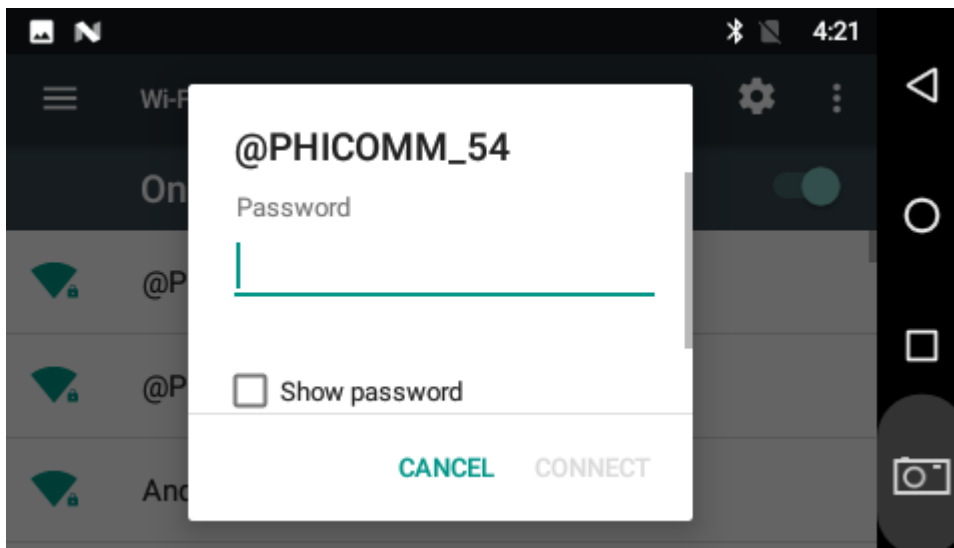

Ethernet

Be sure to turn off Wi-Fi if you want to connect your device to the Internet through Ethernet. Plug the Ethernet cable into your device's Ethernet port (#10 in Device Instruction).

In the App list, tap **“Settings”**  to open the system settings app, and select **“More”**. Tap **“Ethernet”**.

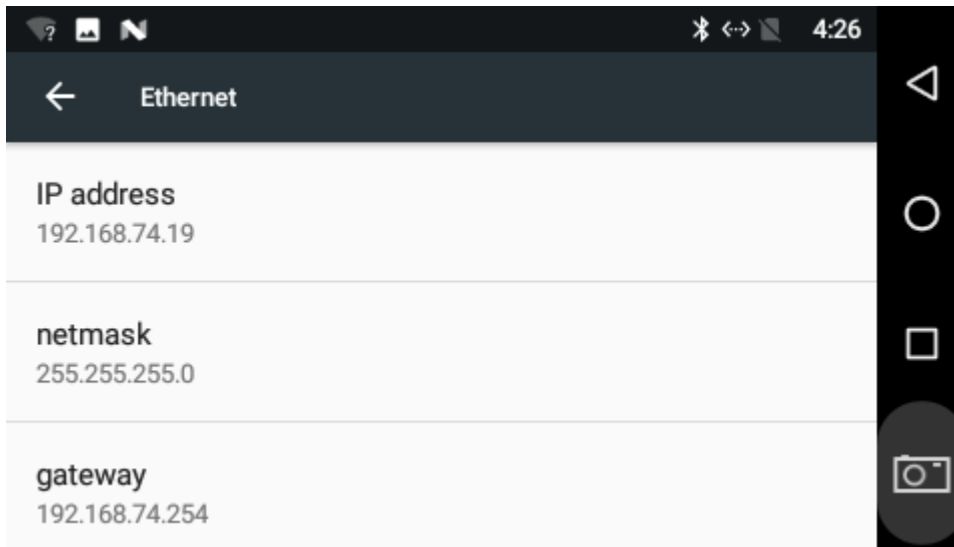

If you want to specify a static IP address for your device, tap **“Ethernet Ip mode”** then **“static”**, and enter the IP address, gateway, netmask and DNS server. Tap **“CONNECT”**.

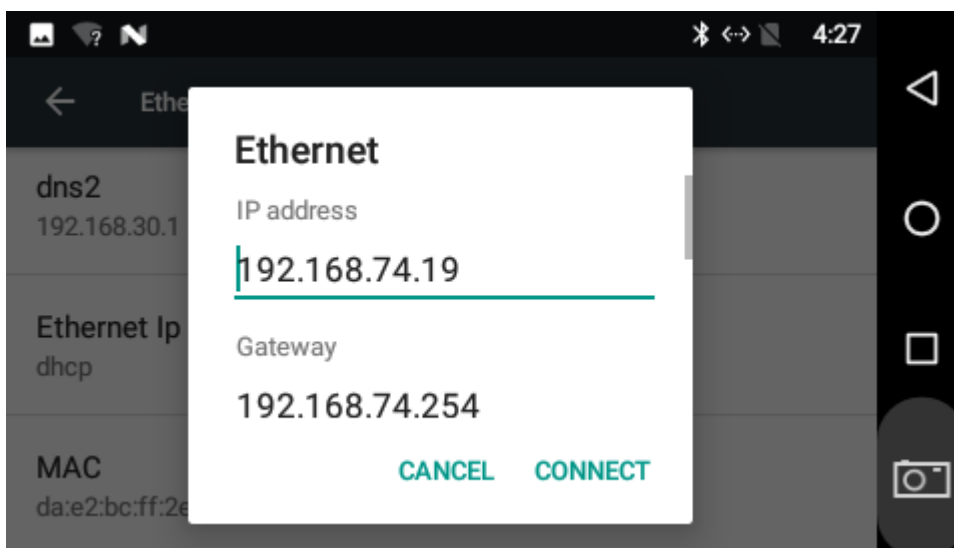

Bluetooth

You can set up a Bluetooth connection between the device and other Bluetooth devices, such as PC, mobile phone. Note that Bluetooth connection works better if there are no obstacles between them.

Pair your device to a Bluetooth device: In the App list, tap “**Settings**”  to open the system settings app, and select “**Bluetooth**”. Turn Bluetooth on to search for available Bluetooth devices. Select the desired device from the search results and then tap “**PAIR**”.

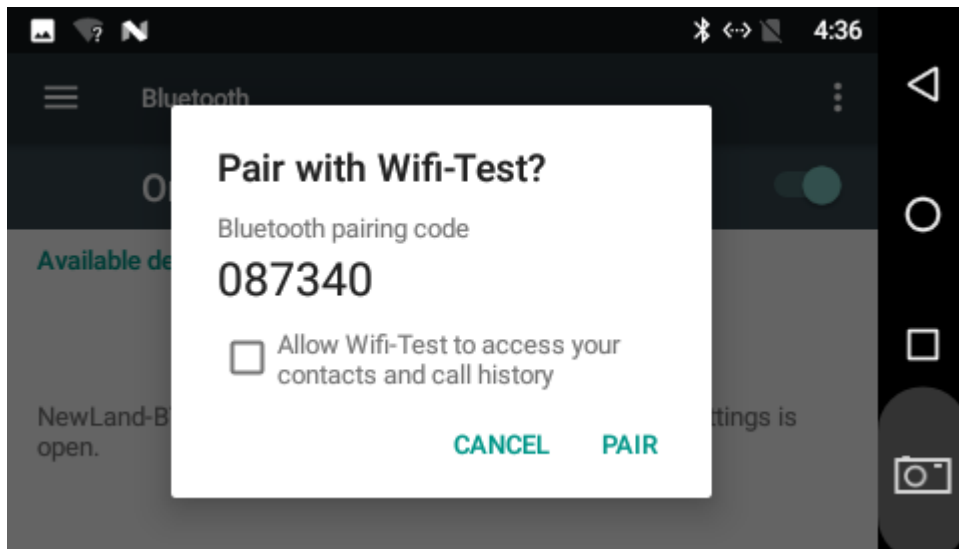

After pairing, the paired device will be moved to the “Paired Devices” list.

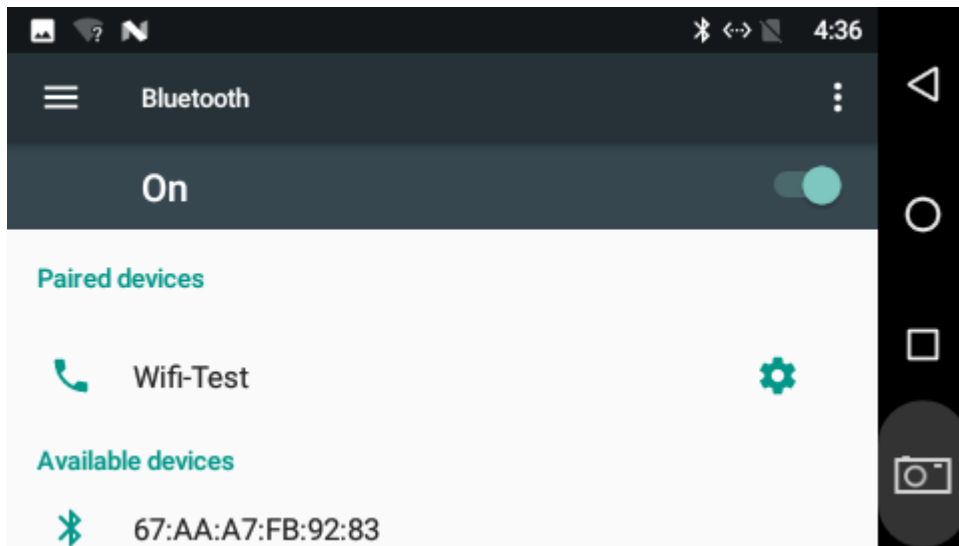

Virtual Keyboard

The device provides a virtual keyboard for typing. You can use it as a real one.

When you tap a text input field, the virtual keyboard will appear at the bottom of the screen.

To close the virtual keyboard, you can tap  in the system bar at the bottom of the screen.



Change keyboard: long press the space key , and then select the desired keyboard from the pop-up window.

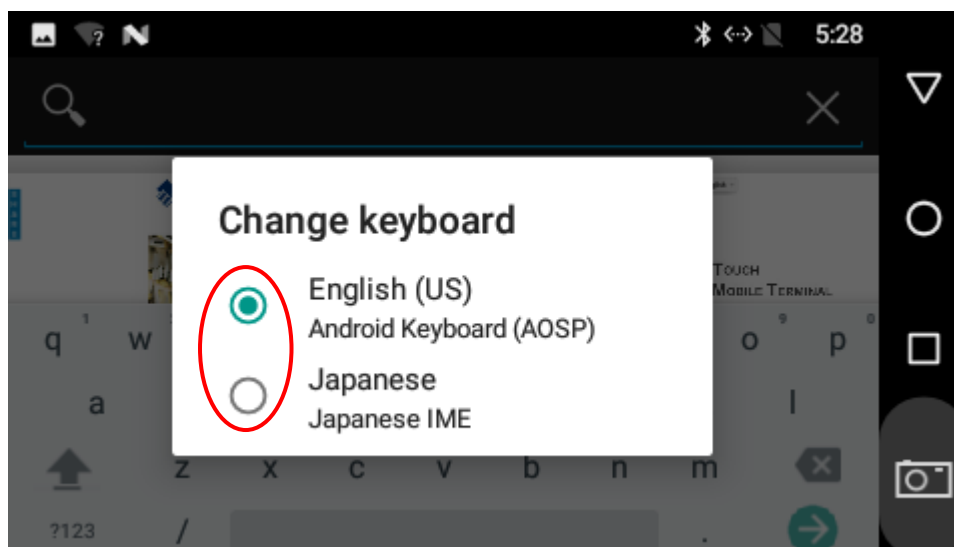

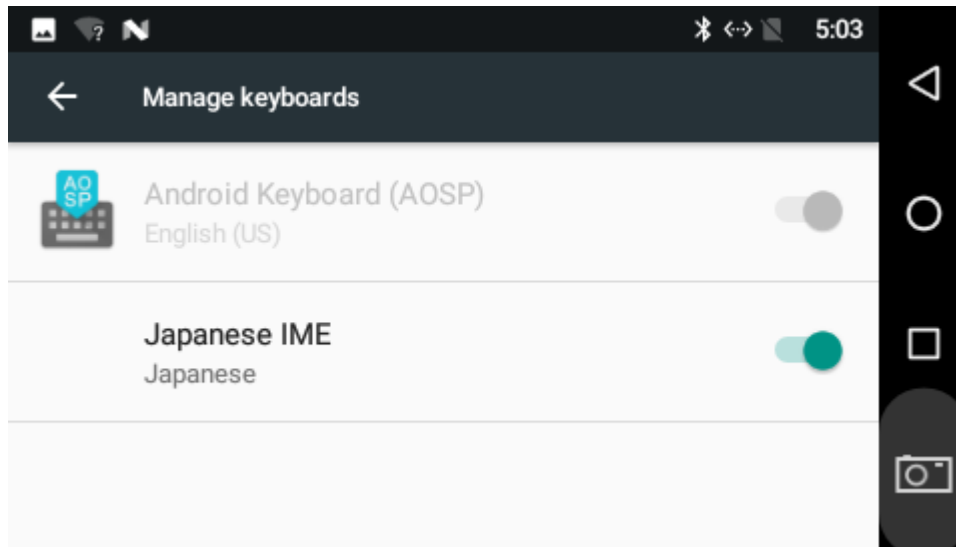

If the long press the space key can't pop up the change keyboard window, go to **Settings > Languages & input > Virtual keyboard > Manage keyboards** > enable the input method(s) you want to use.



Surf Online

In the App list, tap  to launch the Browser app.

When connecting the device to a network, you can visit websites, play online media or download files via the browser.

In a browser window, enter a URL into the address bar and tap  on the virtual keyboard to open the URL. You can also tap , then  to add new tabs to open multiple webpages simultaneously in one window.

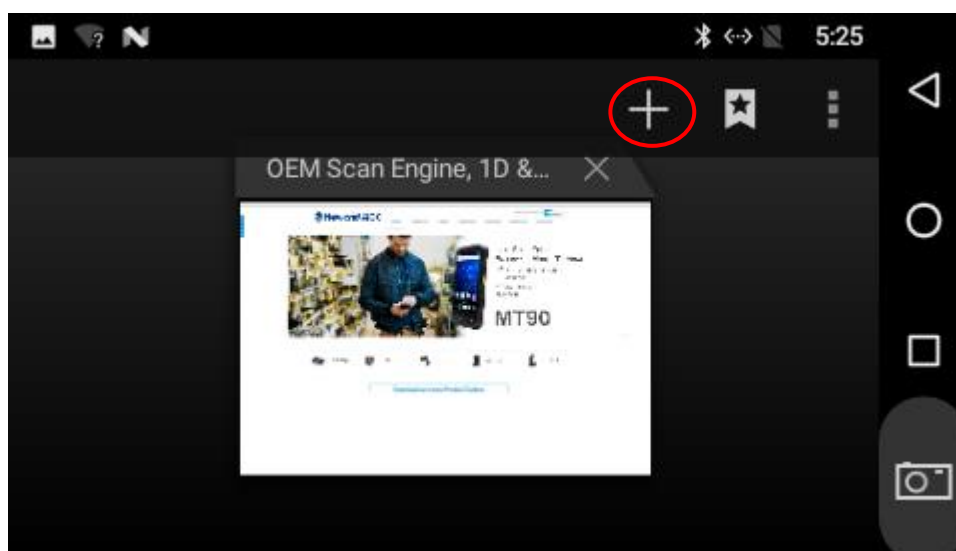
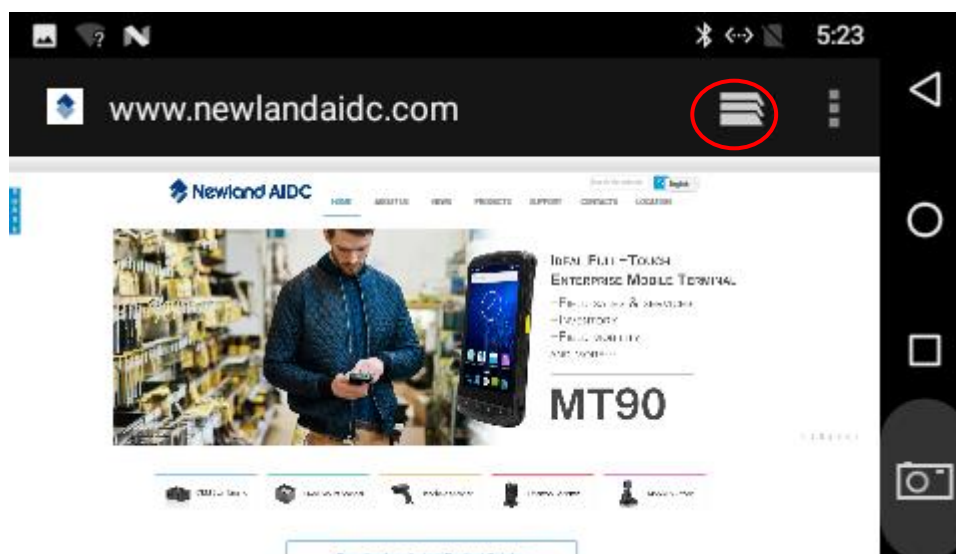

Play Media

With the provided apps, you can play your media files on your storage, such as pictures, music, and videos.



Picture Player:

Support JPG, BMP, GIF, PNG



Music Player:

Support MP2, WMA, WAV, AAC, OGG, ASF.



Video Player:

Support MKV, TS, FLV, AVI, VOB, MPG, DAT, ASF, RM, MOV, 3GP, MP4, WMV

Reset to Factory Default

Please make sure to back up the important data before resetting the device.

In the App list, tap **“Settings”**  to open the system settings app, and select **“Backup & reset”**.

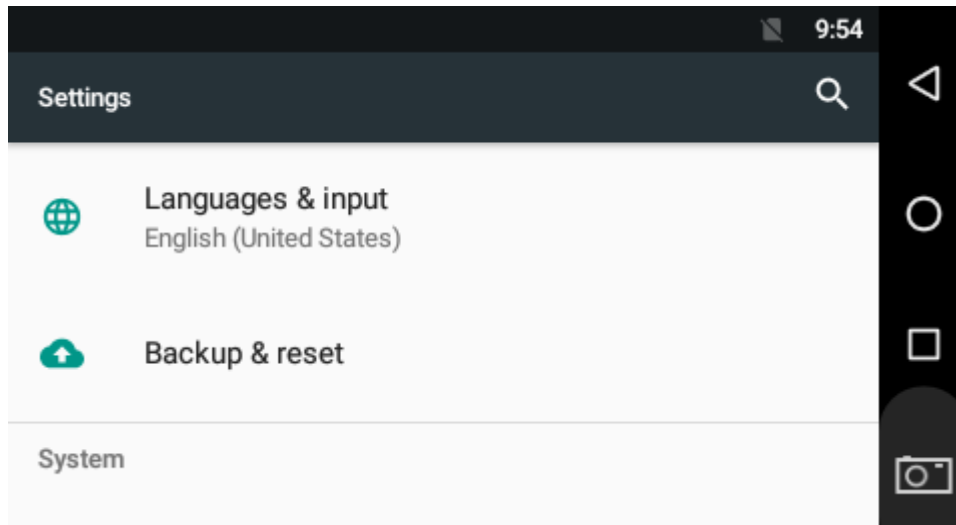

Tap **“Factory data reset”**.

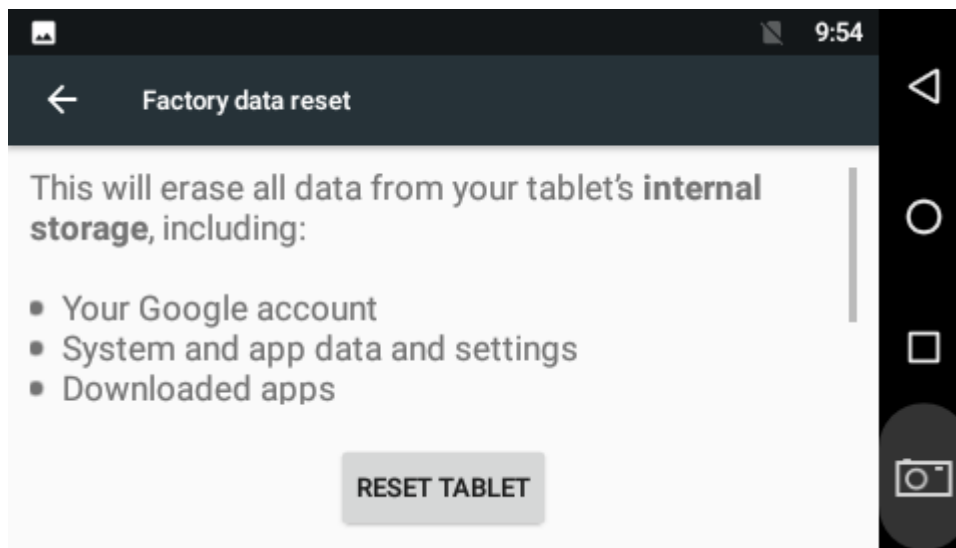

Tap the “**RESET TABLET**” button.

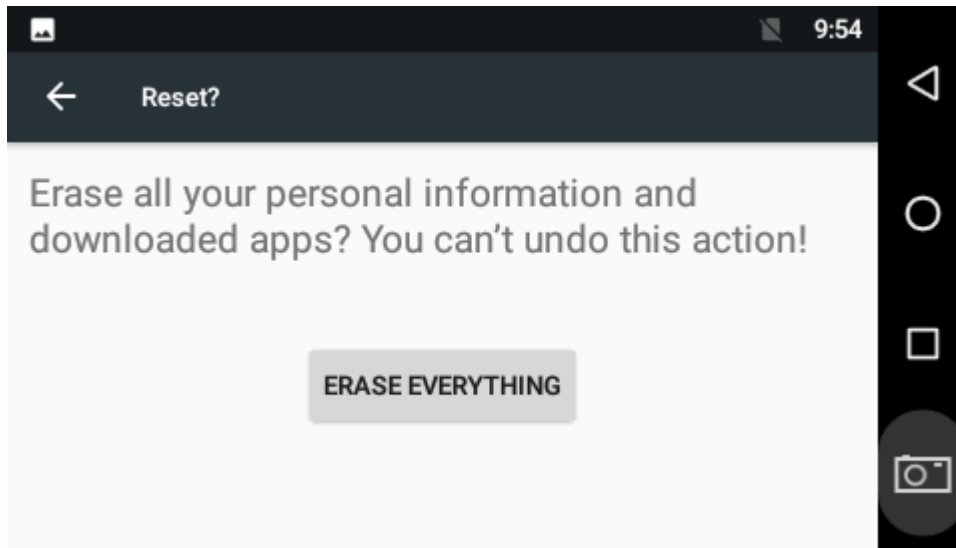

Tap the “**ERASE EVERYTHING**” button. Then the device will reboot and reset to factory default.

Chapter 4 Configuring the NQuire

Introduction

You may configure the NQuire with the web-based tool or by scanning programming barcodes.

Configuring the NQuire with the Web-based Tool

The NQuire has a built-in web server which can be used for device configuration. This configuration method effectively bypasses the restrictions imposed by operating system. You may access the configuration tool by following the instructions below.

1. Open a web browser on your PC (IE11 is recommended).
2. Enter the NQuire's default IP address 192.168.1.200 in the address bar and then press Enter to open the NQuire configuration tool homepage.

Welcome	
Device name	Newland NQuire 350
Serial number	5OUB09XFN9
Hardware version	NQ300-MB-D6-V03
Firmware version	NQuire350-G_V1.01.004
Application build date	Thu Feb 13 02:20:07 UTC 2020
MAC ethernet	da:e2:bc:ff:2e:f2
MAC wifi	c0:84:7d:51:80:62
Scanner module type	CM60
Scanner module firmware	JNI: V1.05.008 uIMG Ver: 4.32.000B92D7 CM60_V1.00.002 HV_V1.0.0
Current IP address	192.168.1.200

If an error page is displayed, please try pinging the NQuire.

- i. Make sure your PC is in the same IP range as the NQuire, e.g. 192.168.1.200.
- ii. Type "ping 192.168.1.200" in your Command Prompt (MS Windows: cmd.exe) and then press Enter.
- iii. If the problem still persists, please double-check the IP address and physical Ethernet connection.

3. Click a menu item on the left pane and set the parameters as per your needs. When you finish making changes to the parameters in a box, click “Apply settings” to save the changes. For the details, see the following sections.

Network Settings

When you click “Network” in the menu, the following page opens. You can specify your own specific network settings here.

Newland Configuration tool

Home
Network
Messages
Scanner
Miscellaneous
Log
Backup
Time
Update
Reboot

wifi

ESSID
Wireless key type WPA or WPA2
Wireless key
Use DHCP No Yes

Ethernet

Use DHCP No Yes
IP address
Netmask
Gateway
Nameserver 1
Nameserver 2

NQuire protocol settings

Mode
UDP port
TCP port
Remote IP address
remote server name
HTTP request string

Wifi: Set the SSID, wireless key, wireless key type and DHCP of the AP the NQuire is going to connect to.

1. Wireless key type: You can choose between three security levels:

None: No encryption key is needed. The NQuire is, via your wireless router, available to all Wifi enabled devices.

WEP: Entry-level encryption with a wireless key to limit network access.

WPA/WPA2: High-end encryption with a wireless key to limit network access.

2. Wireless key: Enter the key which is going to be used to encrypt wireless data communication.

Ethernet: Set the Ethernet port parameters.

Use DHCP: If DHCP is used, an IP address will be automatically assigned to the NQuire; if DHCP is not used, the NQuire has a fixed IP address.

NQuire protocol settings: Set the connect mode, UDP/TCP port and IP address of the server the NQuire is going to connect to.

1. Set connection mode: server (UDP active), client (UDP active), (pure) UDP, TCP server (no UDP), TCP client (no UDP) and TCP client on scan (for non-continuous Ethernet connections such as ISDN). When in server mode, the NQuire will listen to connections on the configured TCP port; when in client mode, the NQuire will try to make the connection using the configured “remote IP address” and “TCP port”. When there are multiple connections (server mode only), scanned data will be sent to all connected servers and sent to the configured UDP server port.
2. Set UDP/TCP port
3. Set remote IP address

Note: 1. The NQuire ignores Wifi when Ethernet is available.

2. When you finish making changes to the parameters in a box, do not forget to click “Apply settings” to save the changes.

Messages Settings

When you click “Messages” in the menu, the following page opens. You can configure idle/error messages and font size here.

Idle message						
Text	X Pos	Y Pos	Vert Align	Hor Align	Size	
Welcome	0	10	top	center	large	
Scan your product	0	50	top	center	small	
↓↓↓↓	0	80	top	center	small	
Picture	<input checked="" type="checkbox"/>	0	0			
<input type="button" value="Apply settings"/>						

Error message						
Text	X Pos	Y Pos	Vert Align	Hor Align	Size	
Please ask	0	30	top	center	small	
for assistance	0	60	top	center	small	
<input type="button" value="Apply settings"/>						

Font sizes		
Font size small	18	
Font size large	28	
<input type="button" value="Apply settings"/>		

Idle message: You can specify what message (containing three lines of text) to be displayed when nothing is scanned. You can define how long the NQuire wait before displaying the idle message after a scan by setting the idle message timeout, as instructed in the “Miscellaneous Settings” section.

1. X Pos/ Y Pos: Set the x and y positions (x: 0-239; y: 0-127) of pixel.
2. Vert Align/ Hor Align: Set the vertical/ horizontal alignment of text. X positions will be ignored unless horizontal alignment is set to “left”; y positions will be ignored unless vertical alignment is set to “top”.
3. Size: Choose between small font and large font.

Error message: You can specify what message (containing two lines of text) to be displayed if the NQuire does not receive a response from the remote server within a preset period of time (i.e. error message timeout) after a scan. See the “Miscellaneous Settings” section to learn how to set the error message timeout.

- ✧ X Pos/ Y Pos: Set the x and y positions (x: 0-239; y: 0-127) of pixel.
- ✧ Vert Align/ Hor Align: Align the text to a position. X positions will be ignored unless horizontal alignment is set to “left”; y positions will be ignored unless vertical alignment is set to “top”.

✧ Size: Choose between small font and large font.

Font Size: Set the size of small/ large font by selecting an option from the corresponding dropdown list.

Note: When you finish making changes to the parameters in a box, do not forget to click “Apply settings” to save the changes.

Scanner Settings

When you click “Scanner” in the menu, the following page opens. You can configure barcode scanner and Mifare scanner parameters here.

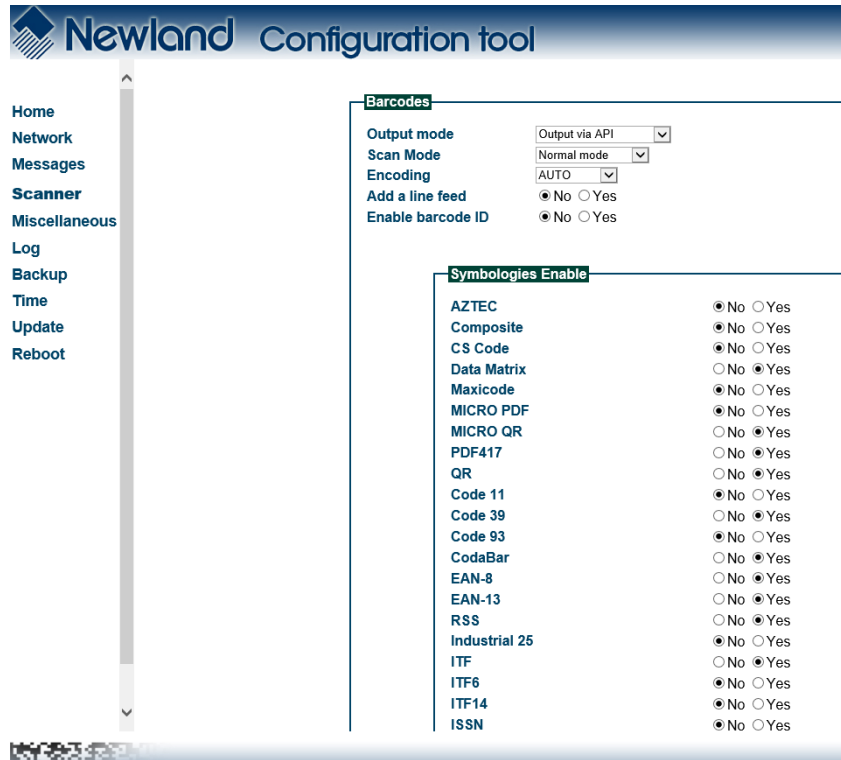

Barcodes

1. Output mode

- ✧ Output via API: Application acquires scanned data by receiving system broadcasts. For the preinstalled CIT app, you should select this output mode.
- ✧ Simulate keystroke: Output scanned data to keyboard buffer to simulate keyboard input.
- ✧ Fill in EditText directly: Output scanned data at the current cursor position in EditText.

2. Scan Mode

- ✧ Normal mode: Presenting a barcode to the NQuire activates a decode session.
- ✧ Continuous mode: The NQuire automatically starts one decode session after another.

3. Encoding: Choose a character encoding to interpret barcode data.

- ✧ AUTO: The terminal determines automatically if target barcode uses UTF-8, GBK, or ISO-8859-1 encoding. If the terminal produces wrong output, you may need to choose or enter a specific character encoding.

- ✧ UTF-8: Dominant Unicode encoding.
 - ✧ GBK: A character encoding for Chinese characters.
 - ✧ ISO-8859-1: A common character encoding which covers Western European languages.
4. Add a line feed: Choose whether to add a line feed after each barcode scanned.
 5. Enable barcode ID: Choose whether to add Code ID before each barcode scanned; customize the Code IDs for symbologies. To add Code ID before scanned data, select “Yes” beside the “Enable barcode ID” item and then click “Apply settings”. To set the Code ID of a symbology, select “Yes” beside the “Enable barcode ID” item, enter your desired Code ID in the corresponding text box beside that symbology and then click “Apply settings”. To restore the default Code IDs of all symbologies, select “Yes” beside the “Enable barcode ID” item and then click “Default ID”. See the “Code ID Table” in Appendix for a complete list of default Code IDs.

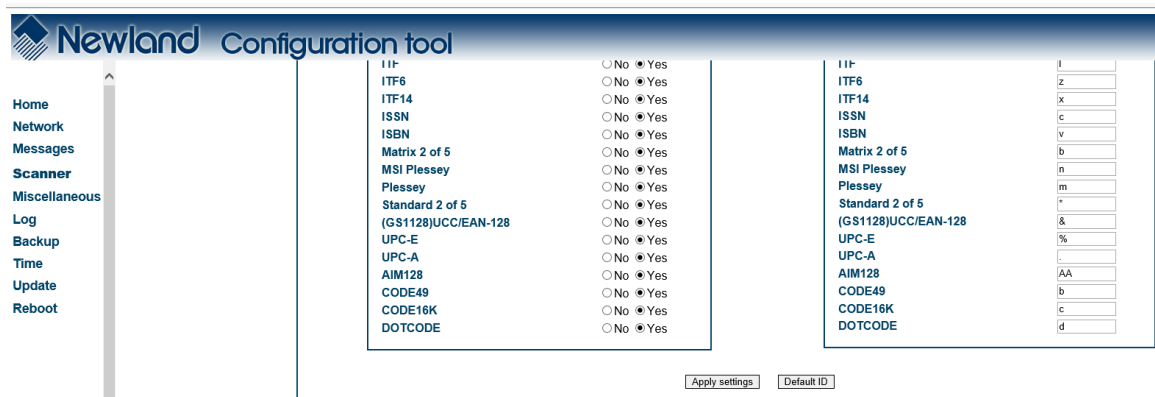
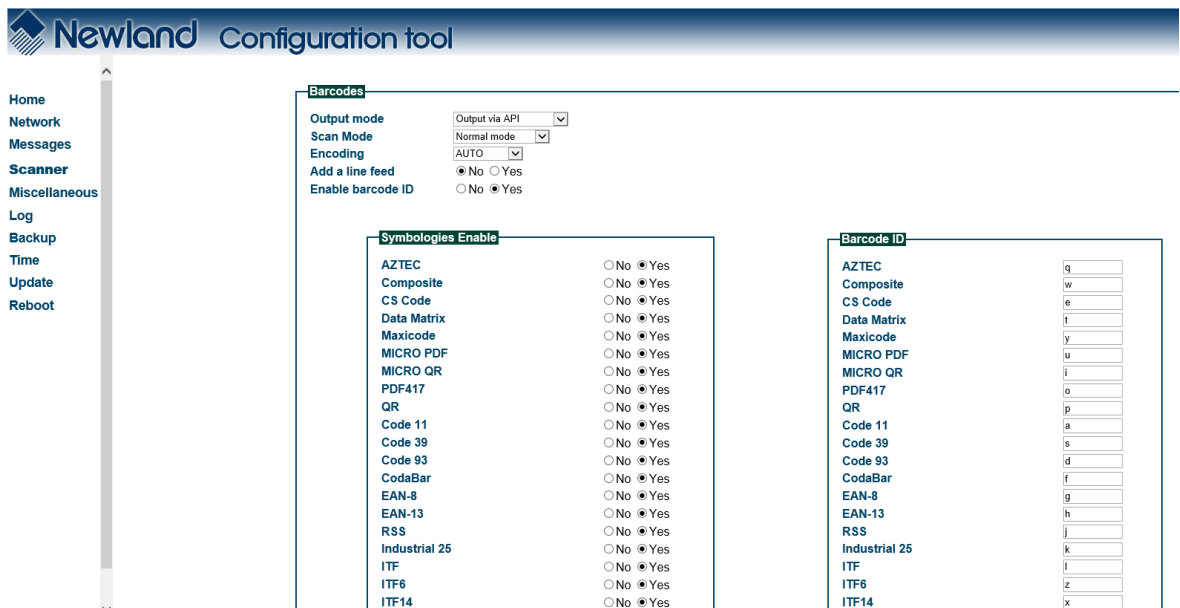

6. Symbologies Enable: Choose whether to enable the NQire to identify the symbologies.

Note: When you finish making changes to the parameters in a box, do not forget to click “Apply settings” to save the changes.

Mifare scanner: Besides scanning barcodes, the CIT app that comes preinstalled on the NQuire also allows users to read from and write to Mifare Classic Mini/1K/2K/4K tags/cards. The following provides instructions for setting the Mifare scanner parameters.

Mifare scanner

Rfid message prefix	<input type="text" value="MF"/>
Access key A	<input type="text" value="FFFFFFFFFFFF"/>
Sectors to read	<input type="text"/>
Cardnum formatting	hexadecimal ▾
Send card number only	<input checked="" type="radio"/> No <input type="radio"/> Yes
Sector data format	base 64 ▾
Sector data seperator	none ▾
Suppress scan beep	<input checked="" type="radio"/> No <input type="radio"/> Yes
Access violation	<input type="text" value="Card access\ndenied"/>
Incomplete scan	<input type="text" value="Wait for beep\nwhen scanning"/>
Write error message	<input type="text" value="Transaction failed!\n\nThis is logged."/>
	<input type="button" value="Apply settings"/>

1. Rfid message prefix: Enter the character(s) (up to 5 characters) you want to add before RFID message.
2. Access key A: Enter the access key A as hexadecimal characters (no key B can be inserted) which has been defined for your Mifare tags/cards.
3. Sector to read: Define which sector(s) and block(s) of the Mifare tag/card should be read in the format of **sector:block,sector:block, sector:block**. For example, **14:0,14:1,15:0** means to read blocks 0 and 1 in sector 14 and block 0 in sector 15.
4. Cardnum formatting: Specify whether tag/card number is transmitted as a hexadecimal number or a binary number.
5. Send card number only: No sectors will be read, just the tag/card number will be sent to the server.
6. Sector data format: Specify whether sector data is transmitted in binary, base64 or hexadecimal format.
7. Sector data separator: Specify what separator is used to separate the different blocks read.
8. Suppress scan beep: Set whether to turn off the beep when the NQuire reads a tag/card.
9. Access violation/ Incomplete scan/ Write error message: You can change these messages as per your actual needs.

Note: When you finish making changes to the parameters in a box, do not forget to click “Apply settings” to save the changes.

Miscellaneous Settings

When you click “Miscellaneous” in the menu, the following page opens. You can configure scanner parameters here.

Newland Configuration tool

Network
Messages
Scanner
Miscellaneous
Log
Backup
Time
Update
Reboot

Device
Device name: Newland NQuire 350
Apply settings

Authentication
Enable authentication: No Yes
Username: _____
Password: _____
Confirm Password: _____
Apply settings

Programming barcode security
Programming mode timeout: 15
Enable security code: No Yes
Barcode programming security code: 0000
Apply settings

Text and messages
Idle message timeout: 3
Error message timeout: 1
Font codepage: ibm852
Scan event separator: LF
Message encryption: none
Use Custom NQuire identifier: No Yes
Custom NQuire identifier: \$(serial): _____
Currency symbol: €
Prohibit prompts when working on keyboard input: No Yes
Reconnect timeout: 5
Apply settings

Interaction
Disable beep after scan: No Yes
Enable launch CIT on boot: No Yes
Enable persistent immersive: No Yes
Display brightness: 30
Scanner sensitivity: normal
Apply settings

GPIO
Server message prefix: I
Append event counter: No Yes
Method: On read GPIO
Poll speed (seconds): 15
Apply settings

Touch screen
Touch message prefix: K
Touch keyboard timeout[seconds]: 60
Apply settings

Device name: Type a random name used for your own administration.

Authentication: You can set a username and password to allow only authorized personnel to log in to the NQuire configuration tool.

Programming barcode security

1. Programming mode timeout: The period of time allowed to elapse before the NQuire returns to idle state when no programming barcode is scanned in seconds. When the timeout expires, the NQuire automatically exits the setup mode.
2. Barcode programming security code: You can set a security code to allow only authorized personnel to program the NQuire with barcodes. After a security code is set and enabled, you need to follow the procedure below for barcode programming: Scan the Enter Setup barcode, then the security code then the other programming barcodes.

Text and messages

1. Idle message timeout: The period of time before the idle message is displayed after a scan in seconds.
2. Error message timeout: The period of time the NQuire waits for a response from the remote server in seconds. When the timeout expires, the error message will be displayed for 5 seconds.
3. Font codepage: Choose either UTF-8 (a multi-byte codepage, universal fontset which supports most used language fonts) or one of the following single-byte codepages.

Codepage	Description
851	DOS Greek
852	“Multilingual” West European Latin-1
866	Cyrillic DOS codepage
874	Thai
1250	Central and East European Latin
1251	Cyrillic
1252	West European Latin-2
1253	Greek
1254	Turkish
1257	Baltic

4. Scan event separator: Scan event separator is added after each barcode scanned. You can set the separator to LF, CR or CRLF.
5. Message encryption: Choose “none” or “base64” as per your application needs.
6. Use custom NQuire identifier: NQuire identifier can be used to distinguish data acquired by one NQuire unit from another. You can choose whether to send the user-defined NQuire identifier or not after a scan. The default NQuire identifier is $\{\text{serial}\}$ which means the NQuire’s serial number.
7. Currency symbol: When a single-byte codepage is selected, received ASCII value 0x80 is displayed as the currency symbol chosen here.

Interaction

1. Disable beep after scan: Enable or disable the emission of good read beep.
2. Enable launch CIT on boot: Choose whether to start built-in CIT app on boot or not.
3. Enable persistent immersive: If you disable the persistent immersive mode by selecting “No”, the status bar and navigation bar will appear with an inward swipe from the top or right edge of the screen when the CIT app is in the immersive mode.
4. Display brightness: Choose an appropriate screen brightness level as per the user environment.
5. Scanner sensitivity: There are three options for setting the IR sensitivity. Choose an appropriate sensitivity level that fits the user environment.

GPIO

1. Server message prefix: Set the prefix that will be added before GPIO input data.
2. Append event counter: Choose to append the count of signal level changes or not as per your actual needs.
3. Method: Choose one of the following three methods to read data from GPIO port:
 - On read GPIO**—Read data using a read command
 - On change**—Read data when signal level changes
 - Poll**—Read data by polling the port
4. Poll speed (seconds): Set the polling interval.

Touch screen

1. Server message prefix: You can define a prefix so that the database identifies the touch “key” similar to identifying a barcode.
2. Touch keyboard timeout (seconds): The time during which the keyboard/button is shown on the screen before the NQuire returns to idle state.

Note: When you finish making changes to the parameters in a box, do not forget to click “Apply settings” to save the changes.

Log Settings

When you click “Log” in the menu, the following page opens. You can configure and manage log level settings here.

The screenshot shows the 'Newland Configuration tool' interface. On the left is a vertical navigation menu with the following items: Home, Network, Messages, Scanner, Miscellaneous, Log (highlighted), Backup, Time, Update, and Reboot. The main content area is divided into two sections. The top section, titled 'System log', contains a text area with two lines of log entries: '----- beginning of system' and '----- beginning of main'. The bottom section, titled 'Log settings', features a 'Logging level' label followed by a dropdown menu currently set to 'info'. Below these sections is an 'Apply settings' button.

Note: When you finish making changes to the parameters, do not forget to click “Apply settings” to save the changes.

Backup

When you click “Backup” in the menu, the following page opens. You can import/export configuration data here.

The screenshot shows the 'Newland Configuration tool' interface. On the left is a vertical menu with the following items: Home, Network, Messages, Scanner, Miscellaneous, Log, Backup, Time, Update, and Reboot. The 'Backup' menu item is highlighted. The main content area contains two sections:

- Backup:** A box with the text 'Click the button below to backup settings:' and a single 'Backup' button.
- Restore:** A box with the text 'Click the button below to Restore settings:'. Below this text is a text input field, a 'Browse...' button, and a 'Restore' button.

Backup: Export all settings from the configuration tool into a json file.

Restore: Import a configuration file into the NQuire.

Time

When you click “Time” in the menu, the following page opens. You can set date and time here.

The screenshot shows the 'Newland Configuration tool' interface. On the left is a vertical menu with the following items: Home, Network, Messages, Scanner, Miscellaneous, Log, Backup, Time (highlighted), Update, and Reboot. The main content area is divided into two sections:

- Time**: This section contains the 'Automatic date & time' option, which is set to 'Yes' (radio button selected). Below this are four dropdown menus: Year (2020), Month (3), Day (5), and Minute (40). There is also an 'Hour' dropdown menu set to 16. An 'Apply settings' button is located at the bottom right of this section.
- Timezone**: This section contains the 'Automatic time zone' option, which is set to 'Yes' (radio button selected). Below this is a dropdown menu for 'Timezone' currently set to 'Beijing (GMT+8:00)'. An 'Apply settings' button is located at the bottom right of this section.

Time

Automatic date & time: Choose whether to automatically adjust the date and time of the NQuire or not. Make sure the NQuire is properly connected to the Internet before using this feature.

Timezone

Automatic time zone: Choose whether to automatically adjust the time zone of the NQuire or not. Make sure the NQuire is equipped with a cellular module and a SIM card from your local carrier before using this feature.

Note: When you finish making changes to the parameters in a box, do not forget to click “Apply settings” to save the changes.

Update

When you click “Update” in the menu, the following page opens. When you want to update system via FTP, you can set the FTP server here.

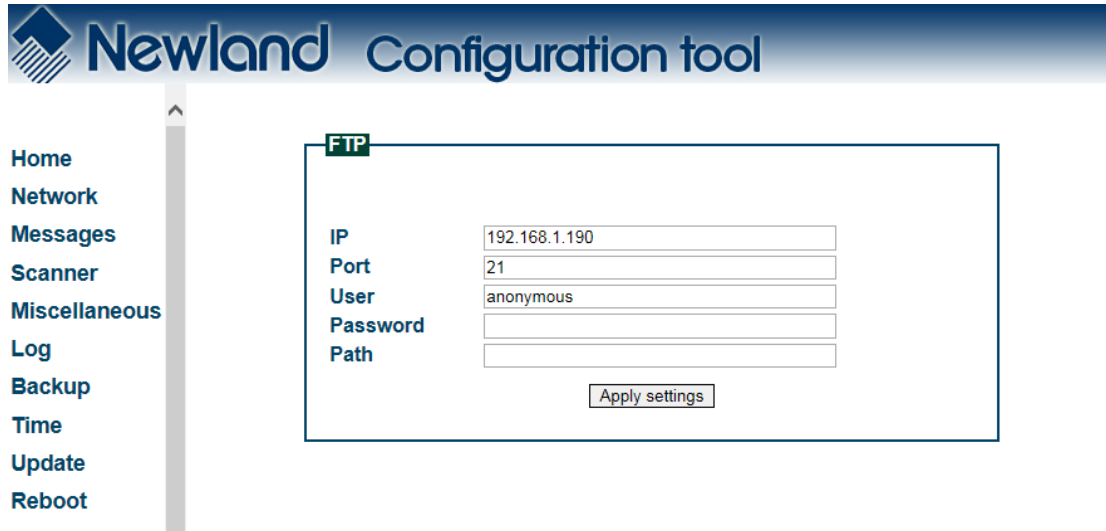

The screenshot displays the 'Newland Configuration tool' interface. On the left is a vertical navigation menu with the following items: Home, Network, Messages, Scanner, Miscellaneous, Log, Backup, Time, Update, and Reboot. The 'Update' option is highlighted. The main content area is titled 'FTP' and contains the following fields:

IP	<input type="text" value="192.168.1.190"/>
Port	<input type="text" value="21"/>
User	<input type="text" value="anonymous"/>
Password	<input type="text"/>
Path	<input type="text"/>

Below the fields is an 'Apply settings' button.

Note: When you finish making changes to the parameters, do not forget to click “Apply settings” to save the changes.

Reboot

When you click “Reboot” in the menu, the following page opens. You can reboot the NQuire and reset it to factory settings here.

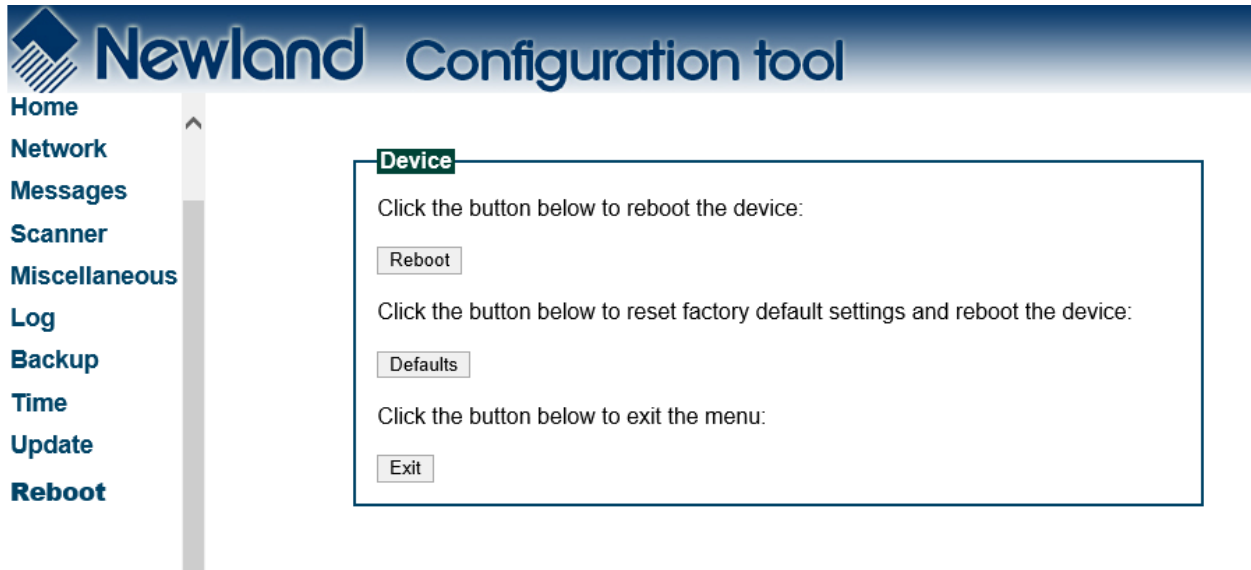

Resetting the NQuire to factory settings will delete all data in user space, including user-defined settings and user-installed apps.

Configuring the NQuire with Programming Barcodes

The NQuire can be configured by scanning programming barcodes which are created in the format of Code 128.

Enter/Exit the Setup Mode

Scanning the **Enter Setup** barcode can enable the NQuire to enter the setup mode. Then you can scan a number of programming barcodes to configure the NQuire. To exit the setup mode, scan the **Exit Setup** barcode.

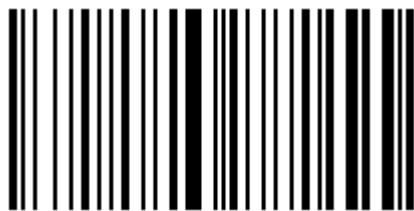

Enter Setup

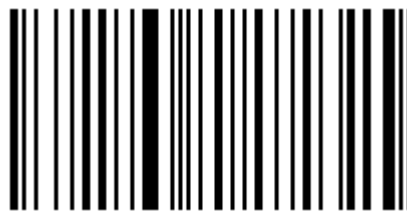

Exit Setup

Enable/Disable DHCP

If DHCP is disabled, the NQuire will have a fixed IP address and it will use the most recently configured IP address. The default IP address is 192.168.1.200

If DHCP is enabled, the NQuire will function in DHCP mode and it is not necessary to put your own network environment in the default range 192.168.1.xxx

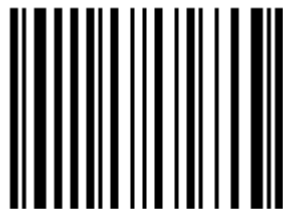

Enable DHCP

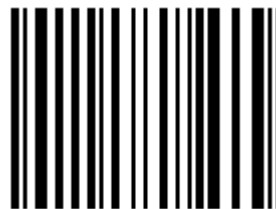

Disable DHCP

Screen Brightness

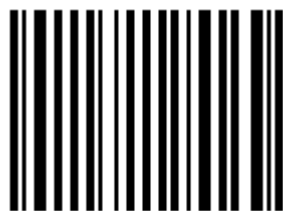

Level 1 (Low)

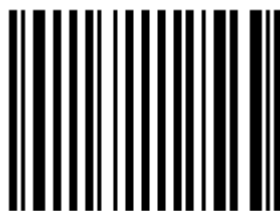

Level 2 (Medium)



Level 3 (High)



Level 4 (Extra High)

Scanner Sensitivity



Normal



High



Max

Beeper

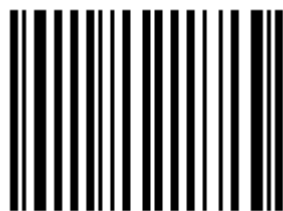

Beeper OFF

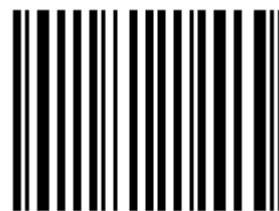

Beeper ON

Reboot



Reboot



Restore Factory Settings & Reboot

Return to Desktop



Return to Desktop

Query Configuration



Query Configuration

Customizing Configuration Barcodes

To streamline the programming process, you may as well create 2D Data Matrix barcodes using existing JSON configuration files or those (cit.json) exported from the web-based NQuire configuration tool. Refer to the “Backup” section in this chapter to learn how to export configuration files from the tool. Note that the data of a customized configuration barcode should be a valid JSON object. It is recommended that you export configuration file using the NQuire configuration tool and then edit it as per your needs.

The following is an example of a user-defined configuration barcode.

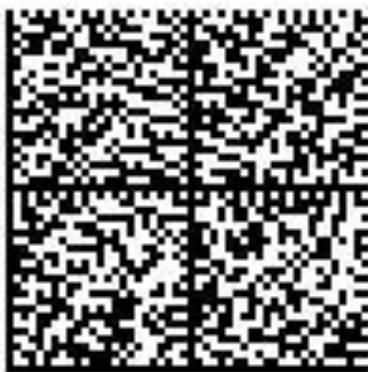

```
{"Network Ethernet": {  
  "Gateway": "192.168.28.254",  
  "Netmask": "255.255.255.0",  
  "Nameserver1": "8.8.8.8",  
  "Nameserver2": "8.8.4.4",  
  "Use DHCP": "No",  
  "IP address": "192.168.28.246"  
}}
```

To put a user-defined configuration barcode into use, scan the following barcodes. (Use the example above.)

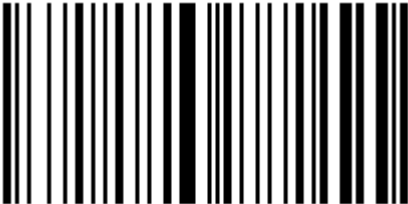

Enter Setup

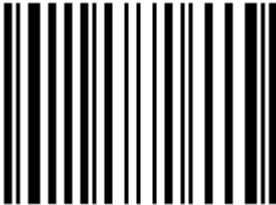

Enable User-Defined Configuration Barcode

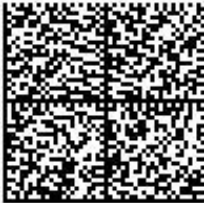

Batch Barcode

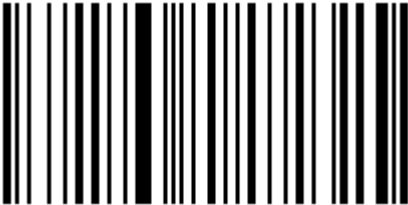

Exit Setup

Chapter 5 Using the NQuire

Introduction

The NQuire receives its input via:

- ✧ 1D/2D barcode scan engine (NQuire350)
- ✧ RFID (NFC) reader.

To scan a barcode or read an RFID tag with the NQuire, follow the instructions below. You may scan a barcode in the “Sample Barcodes” section in Appendix to check if the NQuire reads barcode properly.

Scanning Barcodes with NQuire 350

NQuire 350 is able to read 1D and 2D barcodes. It emits a red crosshair aiming pattern to help the user to easily position the target barcode within the terminal’s field of view to increase scan efficiency.

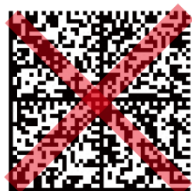

Omnidirectional Scanning (360°)

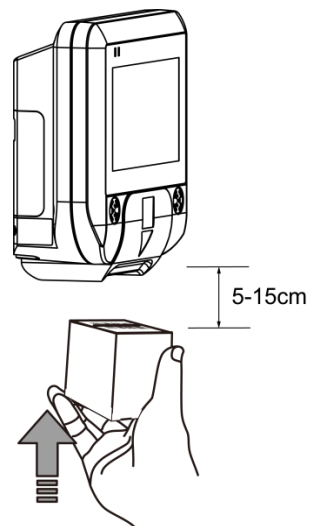

Optimal Scan Distance

Reading RFID Tags

NQuire 350 is equipped with an RFID reader, which is widely used for access control applications. To read an RFID tag or card, place it 0-5cm in front of the RFID antenna.

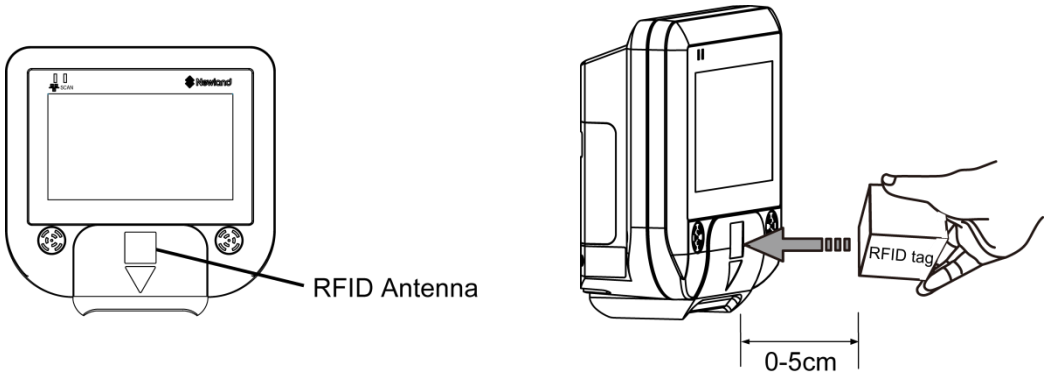

GPIO Device

The NQuire supports interfacing with a GPIO device such as an entry/exit gate, door lock or LED lamp by connecting the signal wires to the GPIO ports.

The pin definitions of the GPIO ports are as follows:

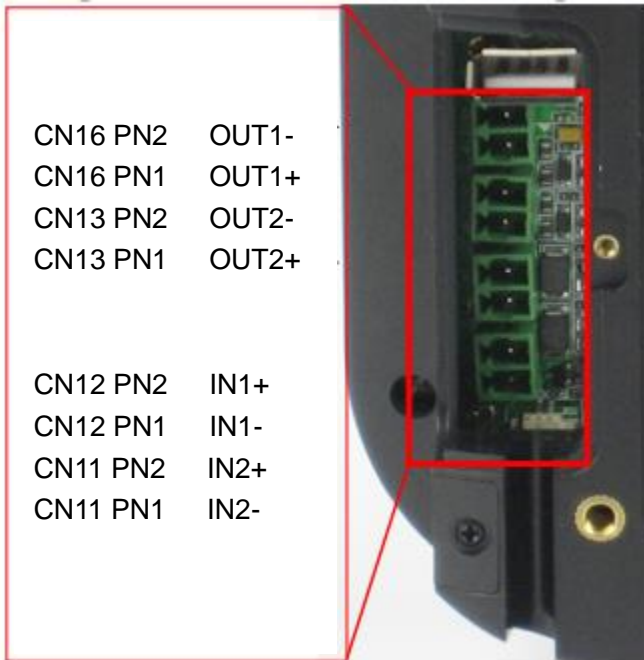

Command to set GPO output

```
\x1b\x7e<param1><param2>
```

Parameter definition:

Param1:\x30 = OUT1

\x31 = OUT2

Param2:\x30 = low

\x31 = high

E.g. setting OUT2 to low:

```
\x1b\x7e\x31\x30
```

Command to get GPI input

```
\x1b\x7f<param>
```

Param can be 1 of:

\x30 = IN1

\x31 = IN2

E.g. requesting the state of IN1:

```
\x1b\x7f\x30
```

This send the value back using the following format:

```
<prefix><pin><value>
```

E.g. with the default prefix for IN1, value high:I01

Please find below an example of how a GPO integration could look like:

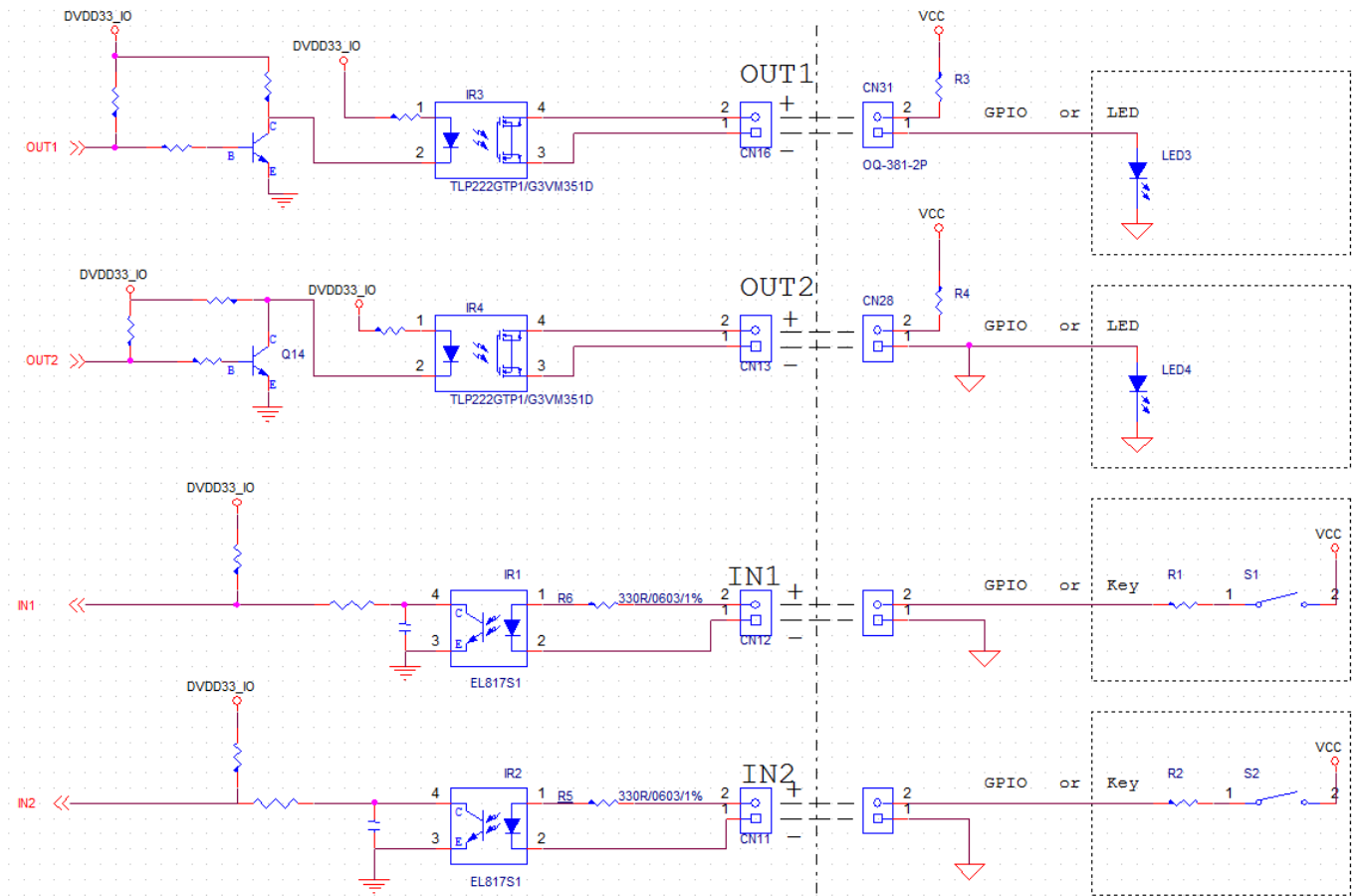

Output:

	Out High	Output Low
OUT1/OUT2	High	Open
LED	ON	OFF
GPIO	High	Low

Input:

	Input High	Input Low
S1/S2	Close	Open
GPIO	High	0V
IN1/IN2	Low	High

R1/R2:

Voltage	3.3V	5V	9V	>9V
R1/R2	0Ω	0Ω	0Ω	(50*VCC-390)Ω

Chapter 6 ESC Commands

Introduction

The NQuire supports ESC commands that perform device controls such as controlling cursor, clearing screen and aligning text.

Text Display

The NQuire uses proportional fonts (every single character has its own specific width) for displaying text. For example, the letter “i” takes up much less horizontal space than the letter “m”. As a result, you hardly know precisely how many characters fit on one line. If a text is too long to fit on one line, some characters will not be shown on the screen. Averagely speaking, up to 20 characters can be display on a single line.

Note: Every received ASCII value (between 20 and 255), which is not part of a command, is normally displayed on the screen.

The following commands control the position and control of text:

- ✧ Carriage Return (for going to the start position of the next line): ESC 0x0D
- ✧ Line Feed (for going to the start position of the next line): ESC 0x0A
- ✧ Set cursor (for predefined cursor positions): ESC 0x27
- ✧ Set pixel position (for placing the cursor on any pixel location): ESC 0x2C
- ✧ Align text (for aligning text to a position such as center of the screen, right of the screen) : ESC 0x2E

NQuire Command Set

ESC	HEX	DEC	CHAR	DESCRIPTION	PARAMETER	
ESC	24 or 25	36 or 37	\$ or %	Clear screen and move cursor to top left corner.		
ESC	27	39	'	Set the cursor position ¹	<POS> 0x30-0x3F	<LINE> 0x30-0x34
ESC	2C	44	,	Set the current pixel position ²	<POS> 0x30-0xAF	<LINE> 0x30-0x6F
ESC	2E	46	.	Align a string of text ³	<ALIGN>0x30-0x3E	<DATA>"..."[0x03]
ESC	42	66	B	Select a font set ⁴ Small font: 0x30 Large font: 0x31	<FONTSET>0x30-0x31	
ESC	5A	90	Z	Reboot the NQuire		
ESC	5B	91	[Enable/Disable barcode scanning	<MODE> Disable: 0x30 Enable: 0x31	
ESC	5C	92	\	Enable/Disable backlight	<MODE> Disable: 0x30 Enable: 0x31	
ESC	5D	93]	Sleep/Wake up barcode scanner	<MODE> Disable: 0x30 Enable: 0x31	
ESC	5E	94	^	Generate the default beep		
ESC	7E	126	~	GP-Out on/off	<PORT> Out1: 0x30 Out2: 0x31	<STATE> Off: 0x30 On: 0x31
ESC	7F	127		State request GP-In	<PORT> In1: 0x30 In2: 0x31	

¹ The actual pixel position depends on the currently selected font set:

- ✧ Every x-position is a multiple of 8 pixels.
- ✧ Every y-position depends on the currently selected font set (height of 24 or 32 pixels)
- ✧ <POS>: 0-15 (0x30 - 0x3F)
- ✧ <LINE>: 0-4 (0x30 - 0x34)

² This allows a text to be displayed anywhere on the screen. Note that a character will be partly displayed when it does not fully fit on the screen.

- ✧ <POS>: 0-127 (0x30 - 0xAF)
- ✧ <LINE>: 0-63 (0x30 - 0x6F)

³ Display a text, using the currently selected font set, on a calculated position on the screen.

<ALIGN>	DESCRIPTION
0x30	Left top
0x31	Center top
0x32	Right top
0x33	Left center
0x34	Center
0x35	Right center
0x36	Left bottom
0x37	Center bottom
0x38	Right bottom

<ALIGN>	DESCRIPTION
0x39	Left, using current y-coordinate
0x3A	Center, using current y-coordinate
0x3B	Right, using current y-coordinate
0x3C	Top, using current x-coordinate
0x3D	Center, using current x-coordinate
0x3E	Bottom, using current x-coordinate

<DATA> field has a maximum length of 25 characters. Use 0x03 (ETX) as the last character, if less characters are used.

⁴ Please find below a list of font sizes which can be used directly in your application code as an alternative to the set which can be configured on the “Messages” page through the Web-based Configuration Tool.

CODE	FONT SIZE
\x1b\x42\x32	6 pixels
\x1b\x42\x33	12 pixels
\x1b\x42\x34	18 pixels
\x1b\x42\x35	24 pixels
\x1b\x42\x36	30 pixels
\x1b\x42\x37	36 pixels
\x1b\x42\x38	42 pixels
\x1b\x42\x39	48 pixels
\x1b\x42\x3A	54 pixels
\x1b\x42\x3B	60 pixels
\x1b\x42\x3C	66 pixels
\x1b\x42\x3D	72 pixels

NQuire discovery protocol

The NQuire discovery protocol can be used to discover all NQuire devices in a network. Another function is to get information about the available NQuires.

Protocol description

The server has to broadcast an UDP packet to the discovery port (239.255.255.250, port 19200) of the NQuire, containing the following text: CIT-DISCOVER-REQUEST;

Version:1

The first line is a discovery packet identifier. The second line is the version of the discovery protocol.

All NQuires receiving the packet and implementing the sent version will respond by broadcasting the following packet to 239.255.255.250, port 19200: CIT-DISCOVER-RESPONSE; Device name; Application version; Application build nr; Serial number; IP-Address; MAC-Address.

Note: The protocol for a certain version will not change. Any change will result in an increased version number in the “CIT-DISCOVER-REQUEST” packet.

Controlling the touch screen

The NQuire has a touch layer on the screen containing 16 free-definable “buttons”. The picture shown on the screen is related to 1 or more touchscreen buttons.

The names of the images/buttons should not be too long and should not contain spaces. Together they can have 64-16-3=45 characters. Pre-defined buttons can be downloaded from the NQuire via the FTP directory “img”. You can upload your own .gif files into this directory as well.

`\xf2<xxx.gif>\x0d\x0d<position by key-id><coupled to key-id>n\x03`

Touch screen position layout:

0	1	2	3
4	5	6	7
8	9	a	b
c	d	e	f

Examples

Example 1

COMMAND	DESCRIPTION
\x1b\x42\x30	Small font
\x1b\x24	Clear screen, move cursor to top left corner
\x1b\x21.gif\x0d\x0d44\x03\x1b\x22.gif\x0d\x0d55\x03\x1b\x23.gif\x0d\x0d66\x03\x1b\x2ok.gif\x0d\x0d77\x03\x1b\x24.gif\x0d\x0d88\x03\x1b\x25.gif\x0d\x0d99\x03\x1b\x26.gif\x0d\x0daa\x03\x1b\x2cancel.gif\x0d\x0dbb\x03\x1b\x27.gif\x0d\x0dcc\x03\x1b\x28.gif\x0d\x0ddd\x03\x1b\x29.gif\x0d\x0dee\x03\x1b\x20.gif\x0d\x0dff\x03	Align image buttons on screen
\x1b\x42\x30\x1b\x2c\x30\x35Welcome \${user} Code: \x03	Small font, clear screen, move cursor to top, and align text to right center

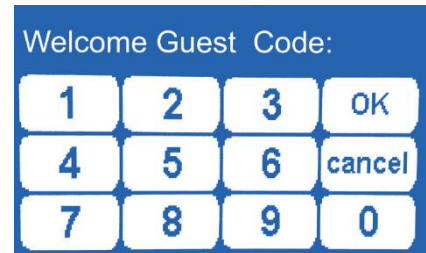

Example 2

COMMAND	DESCRIPTION
\x1b\x42\x30	Small font
\x1b\x25	Clear screen, move cursor to top left corner
Cheese	Text to be displayed
\x0d	Carriage Return
500 gr.	Text to be displayed
\x1b\x42\x31	Large font
\x1b\x2e\x38\x80 5.69\x03	Align text to right bottom



Example 3

COMMAND	DESCRIPTION
\x1b\x42\x31	Large font
\x1b\x24	Clear screen, move cursor to top left corner
\x1b\x2e\x31Special offer!\x03	Align text to center top
\x1b\x42\x30	Small font
\x1b\x2e\x346-pack water 0.5L\x03	Align text to center
\x1b\x42\x31	Large font
\x1b\x2e\x37\x80 0.99\x03	Align text to center bottom



Note: The notation of x1b is the hexadecimal value of <ESC> in the “NQuire Command Set” table. Notation of, for example, \x25 means hexadecimal value 25.

Chapter 7 System Update

Introduction

The NQuire system can be updated by three methods: using a USB flash drive, via FTP or System Update app.

Updating System with a USB Flash Drive

1. Please contact the local FAE to get the NQuire OTA update zip file and save it under the root directory of a USB flash drive (FAT32 format).

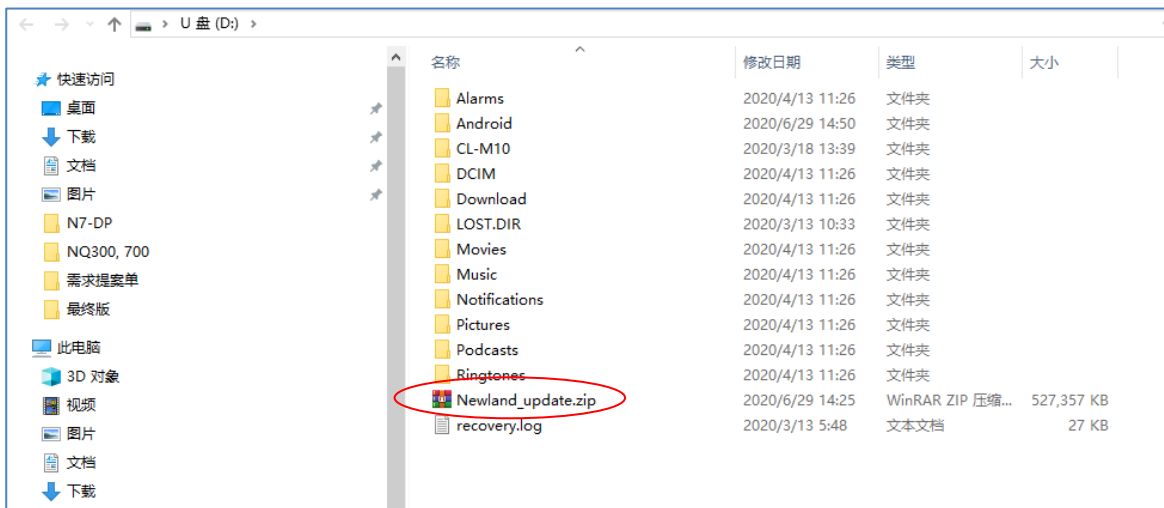

2. De-energize the NQuire, plug the USB flash drive into the USB Host or USB Host/Slave port on the back of the NQuire and re-energize the NQuire. Then the NQuire will automatically begin the update process.

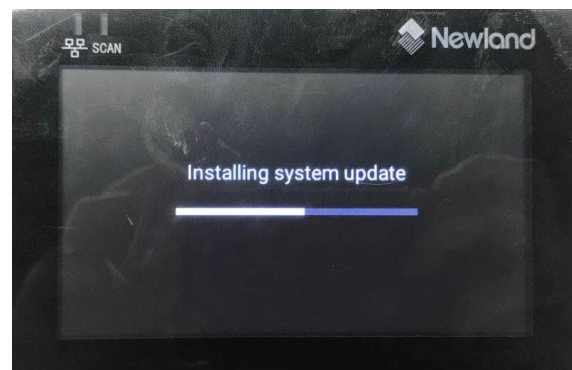
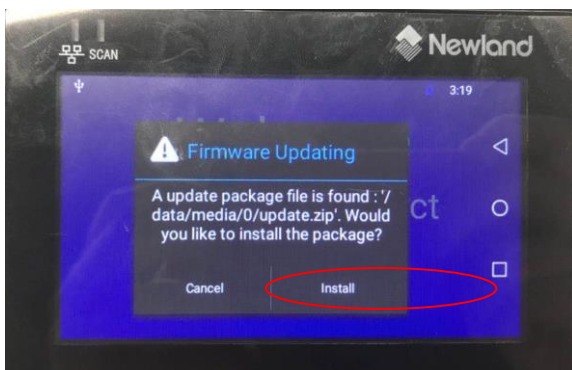

3. Wait for the update process to complete and for the NQuire to automatically reboot. When the NQuire go to **Boot Animation** again, please remove the USB flash drive or it will repeatedly.update the NQuire



Updating System via FTP

1. Ensure that the NQuire and the FTP server are on the same LAN, that network settings are properly configured for the NQuire and that you can connect to the FTP server. Open a web browser and access the NQuire Configuration Tool homepage. Click “Update” and then configure the FTP server and click “Apply settings” to save the settings.

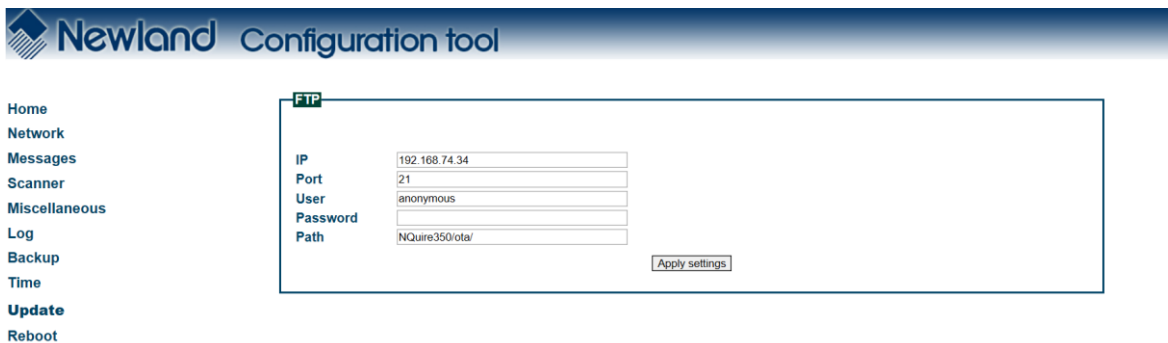

2. Create a directory called “nquire350” under the FTP server’s root directory.

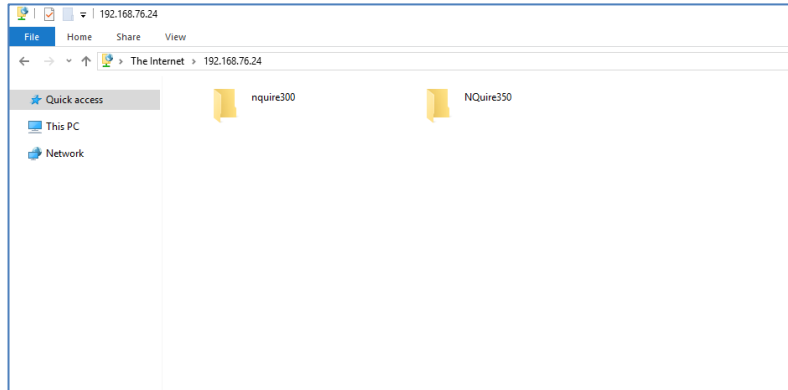

3. Create three directories named “ota”, “config” and “res” in the nquire350 directory.

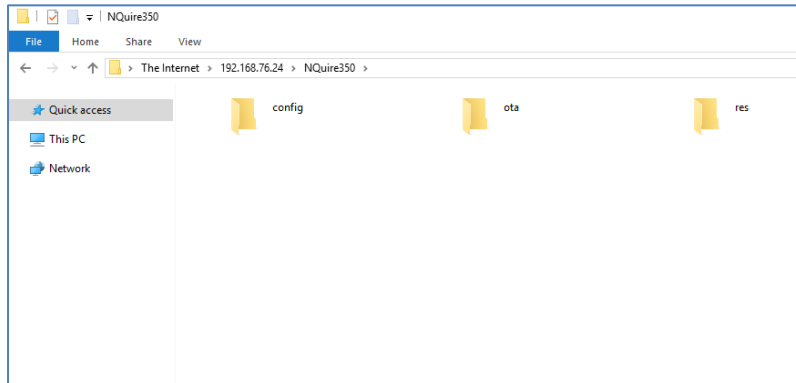

4. Please contact the local FAE to get the the NQuire 350 OTA update zip file and save it in the ota directory. Do not change the file name.

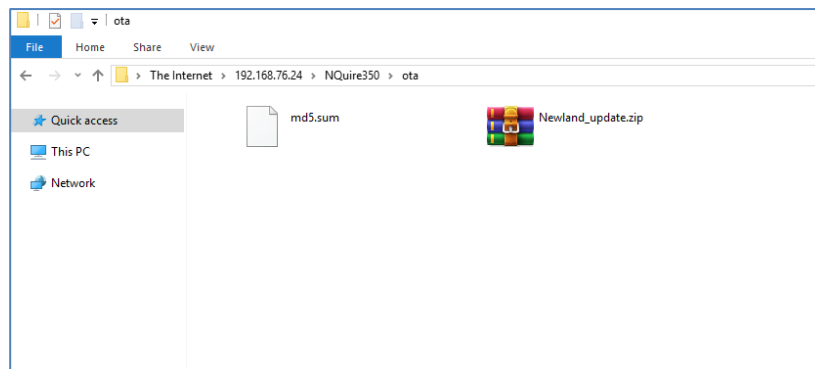

5. Create a text file named md5.sum inside the ota directory. This text file will contain the md5 value of the NQuire OTA update zip file and the file name of the zip file separated by a space character, as shown below.

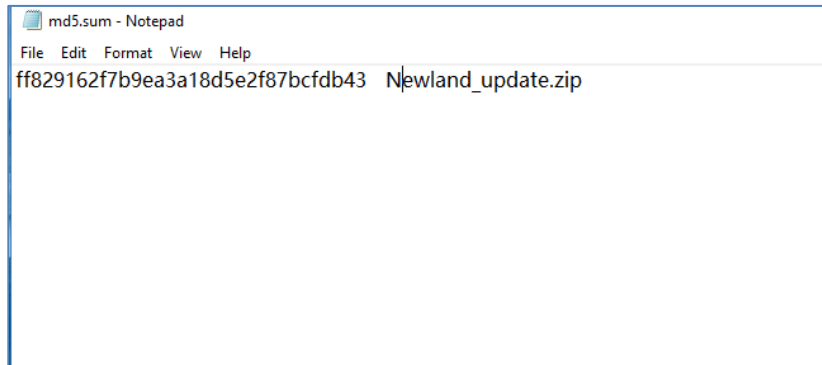

6. If you want to import a configuration file into the NQuire, place the configuration file in the config directory.

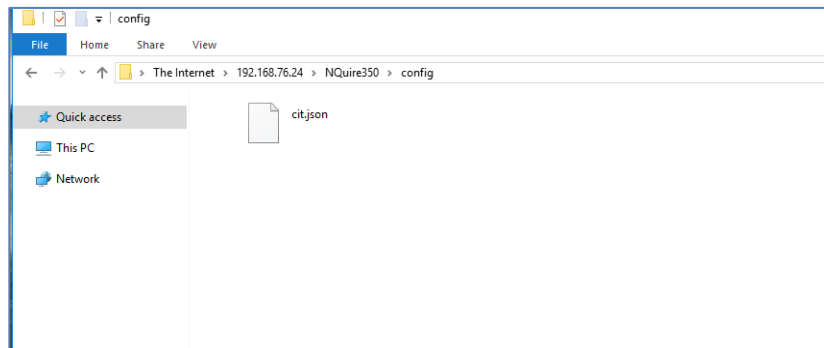

7. If you want to upload resource files such as pictures and video clips to the NQuire, place the files and a text file named md5.sum in the res directory. This text file will contain the md5 value and filename of each resource file separated by a space character. Note that any existing resource files on the NQuire that are not listed in the md5.sumtext file will be deleted after the NQuire downloads resource files from the FTP server and that resource files to be downloaded should not exceed available user storage space on the NQuire (2G bytes in total).

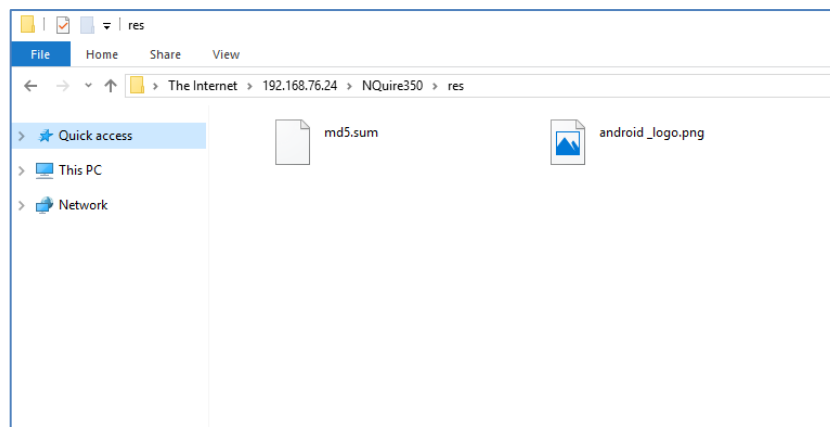

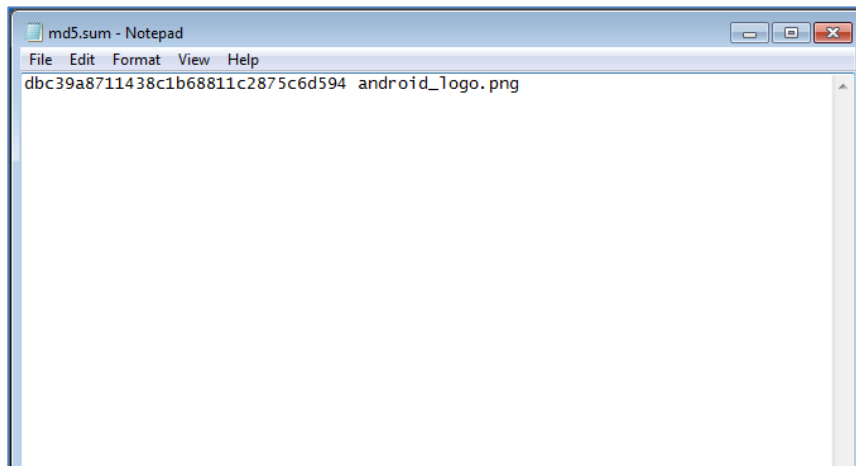

8. Enable FTP service and reboot the NQire. Then the NQire will attempt to connect to the FTP server and perform the following steps:

i. If the NQire detects that there is a later version available on the FTP server, it will automatically reboot and begin the update process.

ii. The NQire will automatically download the resource files in the res directory that are currently unavailable on NQire to /mnt/sdcard/nquire300/res. Your application program may access these files via the path or using Environment.getExternalStorageDirectory()+"/nquire300/res", and use them with remote commands, such as display picture command.

iii. The NQire will automatically download the configuration file from the FTP server if there is one. Note that a reboot is not needed for the new configuration to become effective.

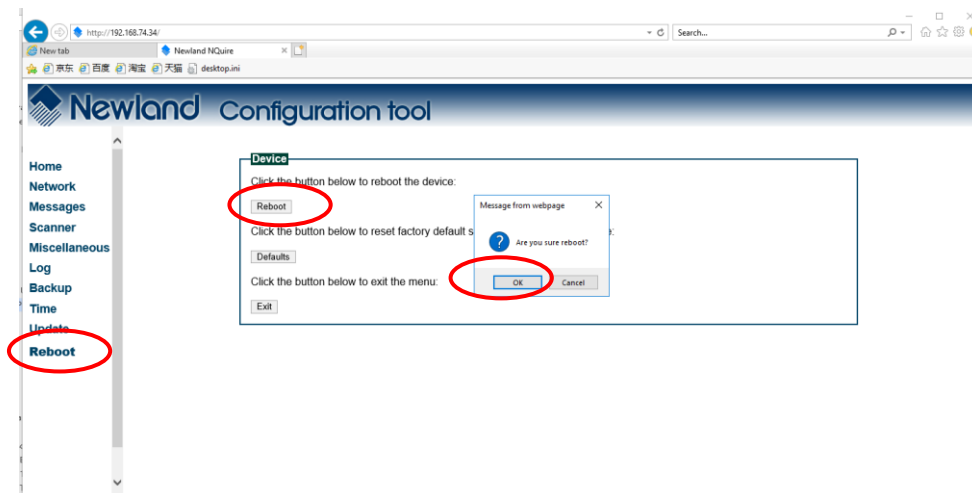

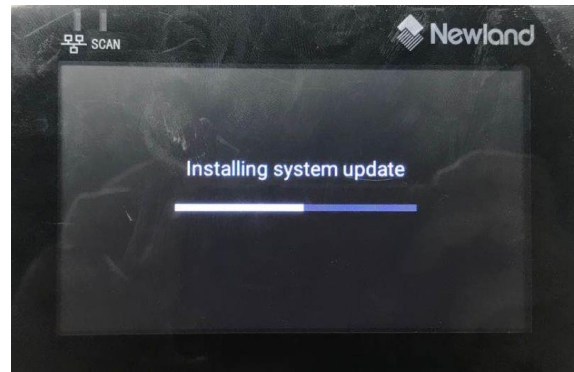

Updating System via System Update app

There are two methods to update the system via system update app: Online update and local update.

Online Update

Update the system online: Tap system updates icon  -> "CHECK FOR UPDATES".

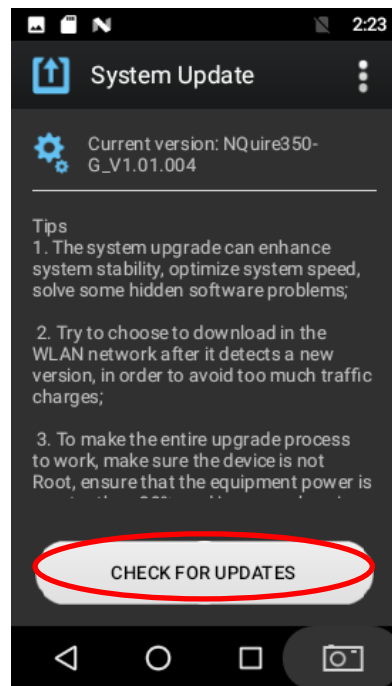
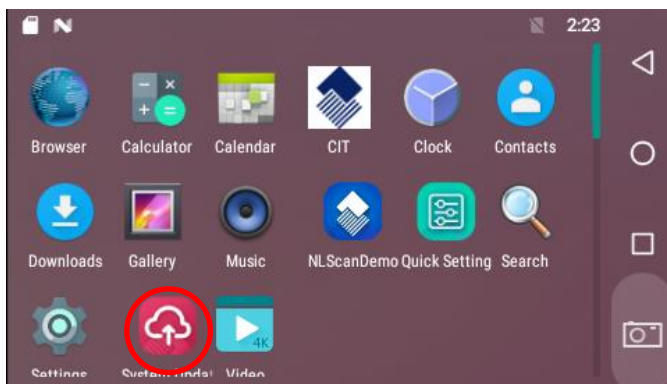

Local Update

Zip File to the NQ350 Drive

Connect the terminal to PC with the included USB cable. Swipe down the screen and it will pop up the notification bar. Find the “USB for file transfer” and tap it, then select “Transfer files”. Details refer to **Enabling MTP** in Chapter 2.

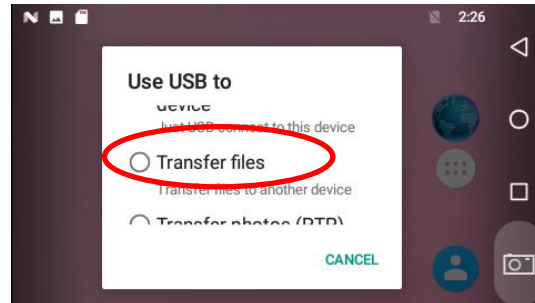
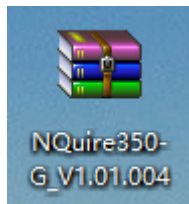

2. Copy the update zip file to the NQ350 drive.

3. Tap  to access the System Update screen.

4. Tap  in the top right corner of the System Update screen then select “Local Update”.

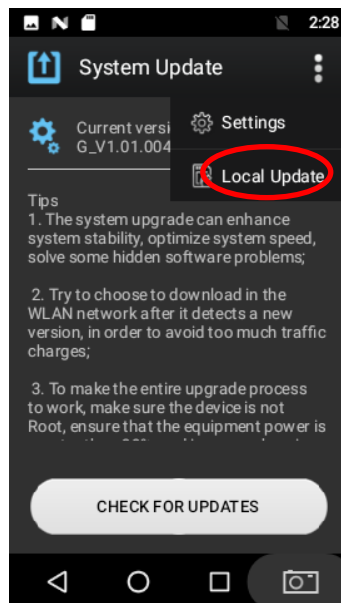

5. Select the update zip file. Then select “NEXTREBOOT” or “UPDATE”.

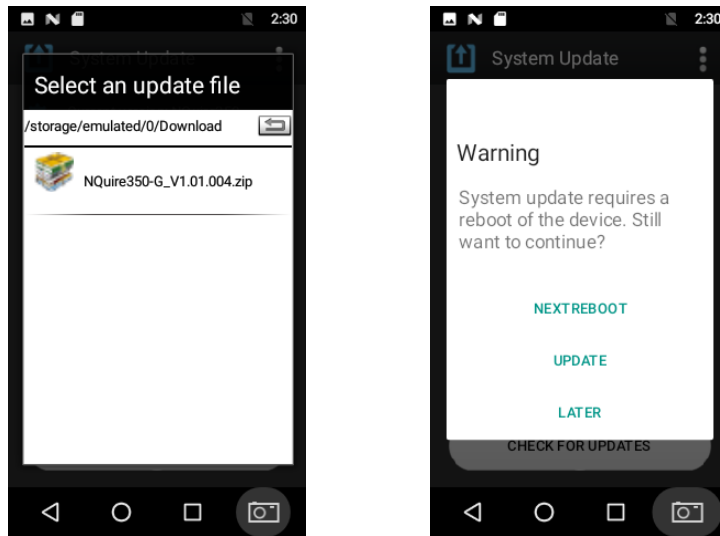

Zip File to TF Card

1. Copy the update zip file to TF Card.

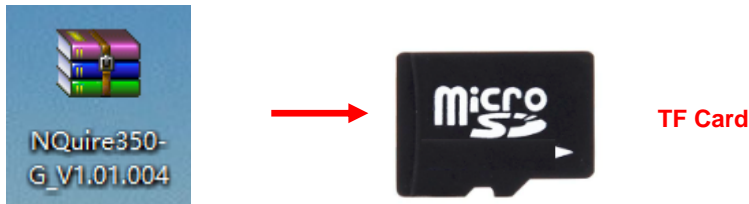

2. Insert the TF card to the NQ350 and then power on the terminal.

3. Tap  to access the System Update screen.

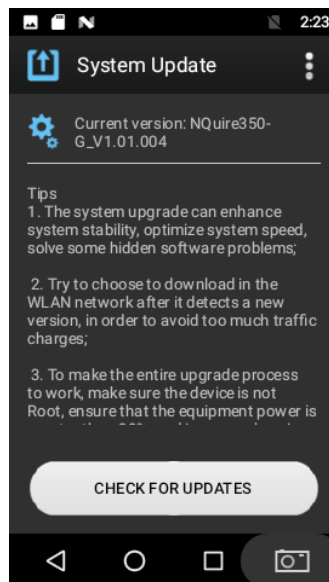

4. Tap  in the top right corner of the System Update screen, and then select “Local Update” -> “External Storage”.

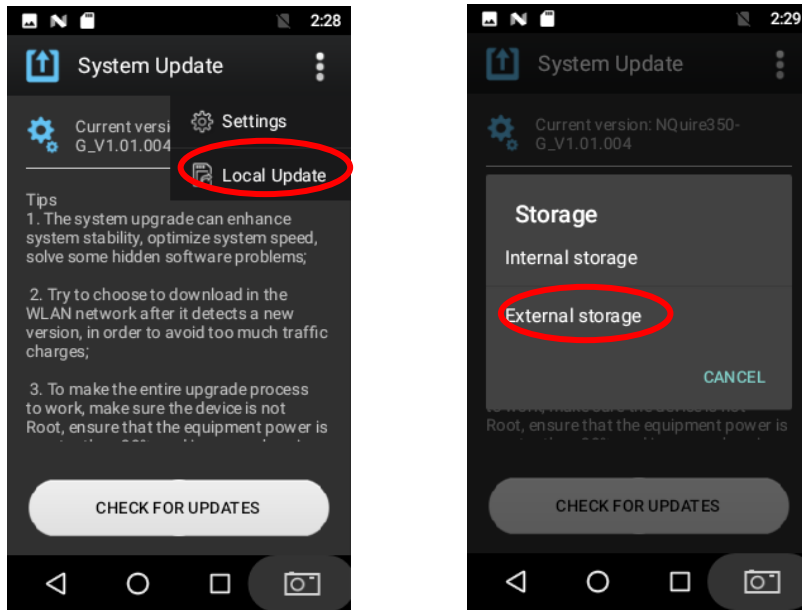

5. Select the update zip file. Then select “NEXTREBOOT” or “UPDATE”.

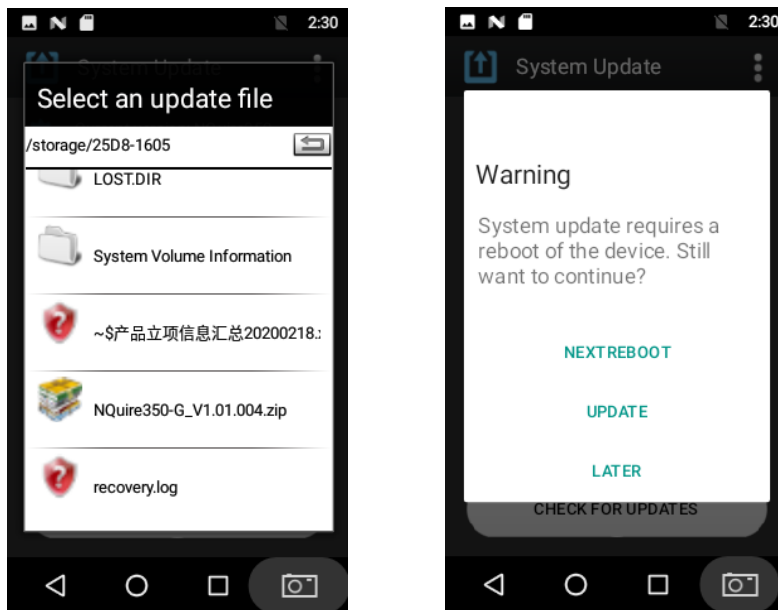

Chapter 8 ADB Debug

Introduction

ADB (Android Debug Bridge) tool can be used to debug apps developed for the NQuire. The following section describes how to use the ADB.

Using the ADB

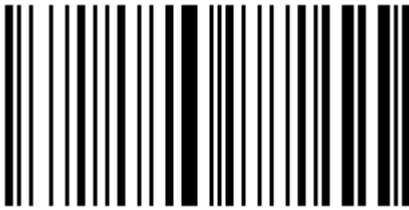

1. Turn on the NQuire. If it displays other screen other than the desktop, scan the **Enter Setup** barcode then **Return to Desktop** barcode to return to the desktop.



Enter Setup



Return to Desktop

2. Tap  on the desktop to view all the app list, then tap “Settings”  to open the system setting app.

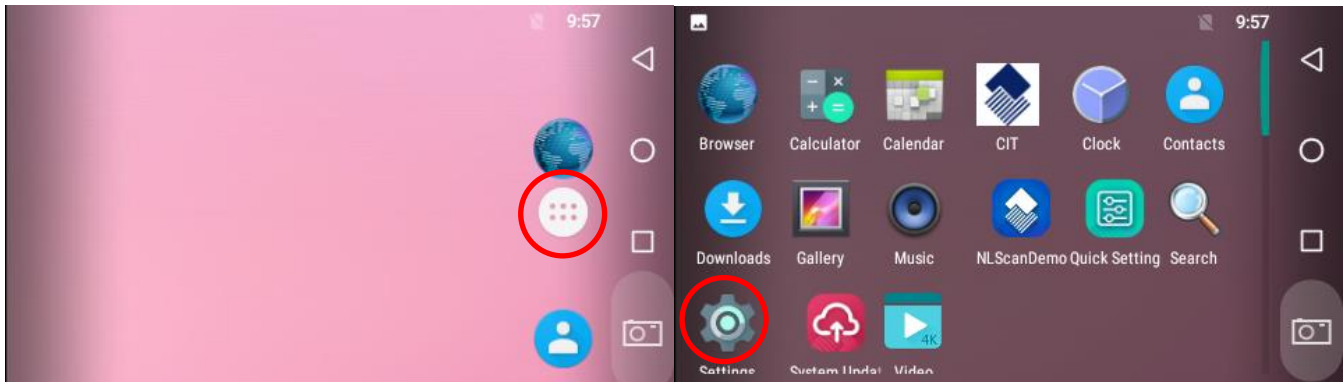

3. Tap “About tablet”.

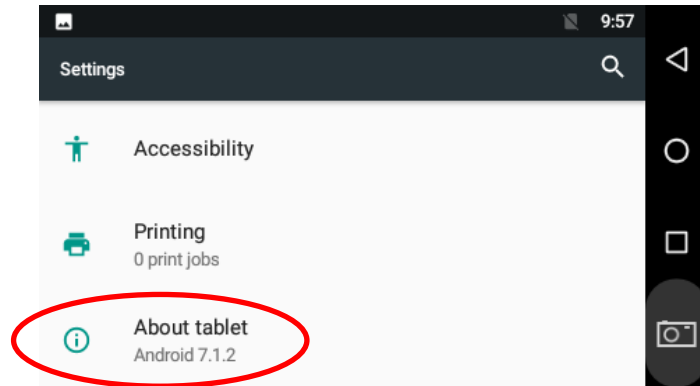

4. Tap “Build number” 7 times to become a developer.

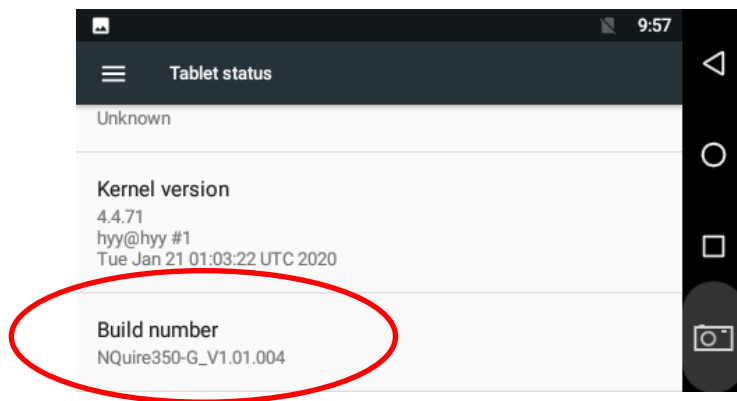

5. Tap  to return to the previous screen.

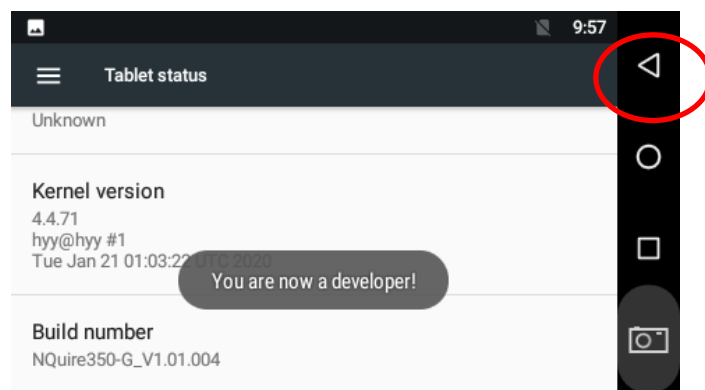

6. Tap “Developer options”.

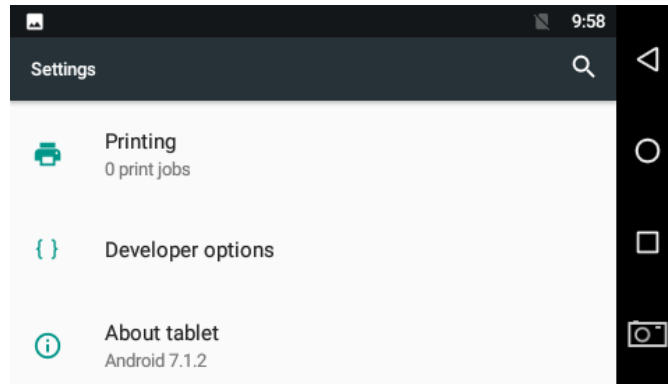

7. Select “Enable OTG”.

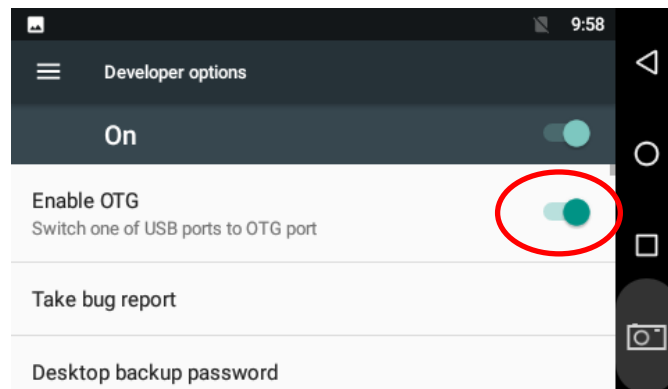

8. Then move down and find “USB debugging” and enable this function. Tap “ok” for the pop-up “Allow USB debugging”.

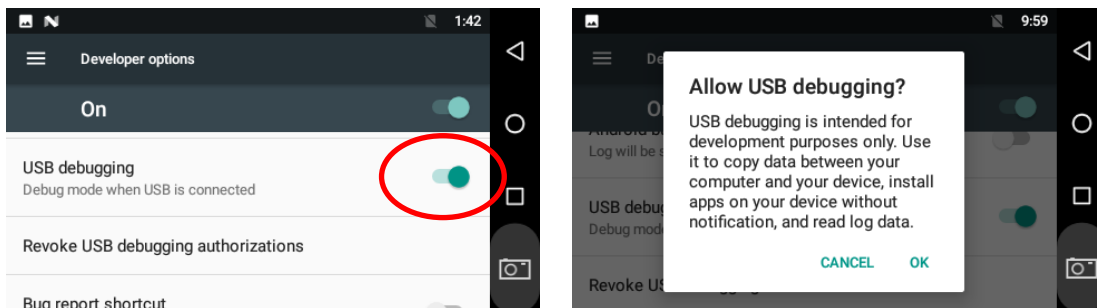

8. Connect the USB Host/Slave port on the NQire to PC with a USB cable (purchase separately).

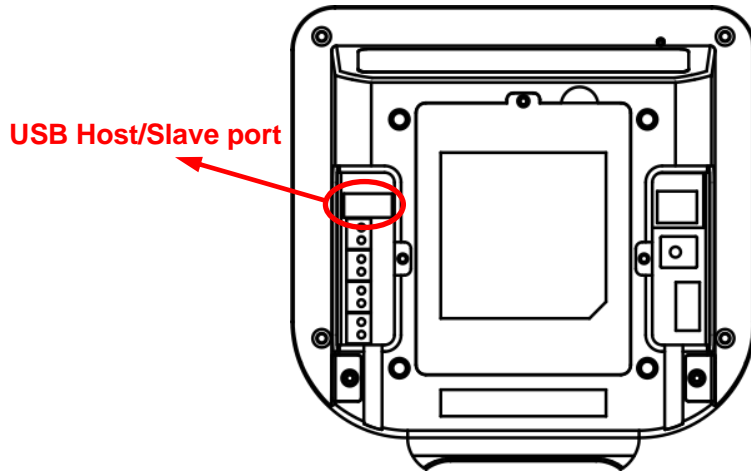

9. Tap "OK".

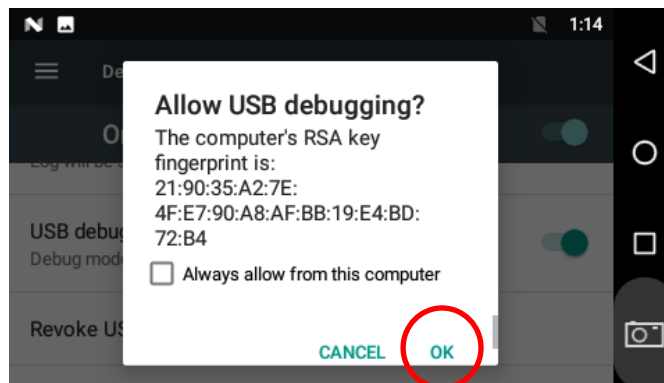

Chapter 9 Using an External Barcode Scanner

Introduction

Usually users scan a barcode by presenting it to the NQuire. However, that may pose a challenge to them when scanning heavy, oversized or bulky items. In this case, using an external handheld barcode scanner can be an ideal solution.

Connecting a Barcode Scanner to the NQuire

Users can connect one of the Newland barcode scanners listed in this Chapter to the USB Host/Slave port or the USB Host port on the NQuire with a USB cable (purchase separately). When using the USB Host/Slave port, OTG must be disabled by unselecting “Enable OTG” on the NQuire. For more information, see the “Using the ADB” section in Chapter 8.

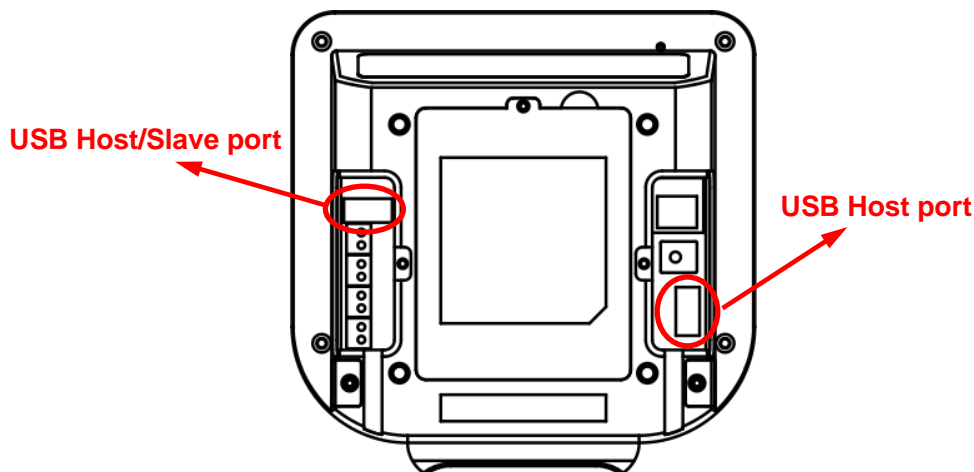

Configuring an External Barcode Scanner

The following sections provide the programming barcodes users may need to configure an external barcode scanner to work with the NQuire.

Configuring NLS-HR11 Plus

Use the barcode scanner to scan the barcodes below row by row, starting with the top left **Enter Setup** barcode, going from left to right, and ending with the **Exit Setup** barcode.



Enter Setup



Restore All Factory Defaults



Enter Setup



USB COM Port Emulation



Enable AIM ID Prefix



Disable Terminating Character Suffix



Exit Setup

Chapter 10 Maintenance & Troubleshooting

Maintenance

Keeping the NQuire Dust-free

To keep the interior of the NQuire clean and your device at peak performance, please always have the two port covers firmly attached.

Cleaning

Regularly clean the scan window on the bottom of the NQuire with a non-abrasive glass spray cleaner and a soft lint-free cloth to keep it free of dust, dirt and fingerprints. Cleaning can be performed during operation.

When cleaning the housing and display screen, please observe the following instructions:

- Use a mild glass spray cleaner;
- spray the cleaner on a soft lint-free cloth;
- wipe the NQuire clean.

The NQuire should **NOT** be cleaned with cleaners containing aromatic hydrocarbons, chloride, acids or oxidizing agents, abrasives, or other aggressive cleaners.

Note: The display screen and scan window are scratch-sensitive, so please clean them carefully!

Troubleshooting

Problem	Possible Cause	Possible Solution
The NQuire will not turn on	No power to the NQuire	<p>Power adapter solution: Connect the approved power adapter to an AC power source and to the power jack on the NQuire.</p> <p>PoE solution:</p> <ol style="list-style-type: none"> 1. Connect one end of an Ethernet cable to the Ethernet port on the NQuire. 2. Connect the other end of the Ethernet cable to PoE power module or PoE switch. 3. Connect DC power to PoE power module or PoE switch if required. 4. Perform continuity check on the Ethernet cable.
The NQuire does not respond to pings from the host computer	No communication between the NQuire and the host computer	<ol style="list-style-type: none"> 1. Check the cables to make sure they are securely connected to the NQuire. 2. Ensure the NQuire's IP address is the address the host computer is pinging. 3. Check communication parameters.
The NQuire does not send data to the host computer	The NQuire is not connected to the host computer	<ol style="list-style-type: none"> 1. Check the cables to make sure they are securely connected to the host computer 2. Check if the NQuire responds to pings from the host computer.
Parameter changes made using web-based configuration tool were not retained after the NQuire rebooted	Parameter changes were not saved	After you change the settings, do not forget to click on "Apply settings" in the corresponding box(es)

Chapter 11 Safety Information

Electrical Safety

1. Use only the included power adapter. Otherwise there is a risk of damage to the NQuire.
2. To avoid risk of electric shock, do not attempt to disassemble or modify the included power adapter yourself.
3. Use only a dry soft cloth to clean the NQuire and power adapter. Cleaning them with wet cloth may cause electric shock or damage to the devices.
4. If there is unusual odor, overheating or smoke when using the NQuire, immediately cut off the power and disconnect the power adapter, and contact your dealer or Newland customer service center. Continued use in this case may result in fire or electric shock.
5. Keep the NQuire and its accessories away from fire and heat sources. Keep them from moisture.

Electromagnetic Compatibility

The NQuire complies with FCC and CE EMC regulations. This device is intended for use in the electromagnetic environment specified below. The customer or the user of the device should assure that the device is used in such an environment.

Guidance and manufacturer's declaration - electromagnetic emissions

Emissions test	Compliance	Electromagnetic environment - guidance
Conducted disturbance at mains terminals	Class B	The device is suitable for use in all establishments, including domestic establishments and those directly connected to the public low-voltage network that supplies buildings used for domestic purposes.
Radiated disturbance	Class B	
Harmonic current emissions	Class A	
Voltage fluctuations & flicker	—	

This device is intended for use in the electromagnetic environment specified below. The customer or the user of the device should assure that the device is used in such an environment.

Guidance and manufacturer's declaration - electromagnetic immunity

Immunity test	EN 61000 test level	Compliance Level	Electromagnetic environment - guidance
Electrostatic discharge (ESD) EN 61000-4-2	± 4KV contact ±8 KV air	±4 KV contact ±8 KV air	Floors should be wood, concrete or ceramic tile. If floors are covered with synthetic material, the relative humidity should be at least 30%.
Radio-frequency, Continuous radiated disturbance EN 61000-4-3	3 V/m 80-1000 MHz	3 V/m	Portable and mobile RF communications equipment should be used no closer to the NQuire than the recommended 10cm separation distance. The NQuire has been designed to meet EMC standards.
Radio-frequency, Continuous conducted disturbance EN 61000-4-6	3 Vrms, (0.15 MHz ~ 80 MHz)	3 Vrms,	However, should you suspect that the device performance (eg. Wi-Fi signal) is affected by other equipment, move the device away from the possible cause of interference.
Electrical fast transient (EFT) EN 61000-4-4	1 KV	1 KV	Mains power quality should be that of a typical commercial or hospital environment.
Surge (Input a.c. power ports) EN 61000-4-5	1.0 KV (1.2/50 us voltage surge, 8/20us current surge)	1.0 KV	Mains power quality should be that of a typical commercial or hospital environment.
Power Frequency magnetic field EN 61000-4-8	1 A/m	1 A/m	Power frequency magnetic fields should be at levels characteristic of a typical location in a typical commercial or hospital environment.
Voltage dips, >95% reduction Voltage dips, 30% reduction Voltage interruptions EN 61000-4-11	0% U_T (>95% dip in U_T) for 0.5P Duration (in periods) 70% U_T (30% dip in U_T) for 25P Duration (in periods) 0% U_T (>95% dip in U_T) for 250P Duration (in periods)	<5% U_T (>95% dip in U_T) for 0.5P Duration (in periods) 70% U_T (30% dip in U_T) for 25 P Duration (in periods) <5% U_T (>95% dip in U_T) for 250P Duration (in periods)	Mains power quality should be that of a typical commercial or hospital environment. If the user of the NQuire requires continued operation during power main interruptions, it is recommended that this device be powered on from an uninterruptible power supply.

Note: U_T is the a.c. mains voltage prior to application of the test level.

Eye Safety

The NQuire uses LEDs to create illumination beam. The LEDs are bright, but testing has been done to demonstrate that the device is safe for its intended application under normal usage conditions. However, the user should avoid looking into the beam.

The NQuire uses a laser diode to form a bright, intuitive aiming aid. It is hazardous to stare into the laser beam.

Others

1. Do not attempt to disassemble or retrofit the device yourself. Unauthorized disassembly or retrofit will void the warranty.
2. If the device is damaged due to a drop from high place, immediately cut off the power and contact your dealer or Newland customer service center.
3. Do not throw, drop or strike the device. Doing so may damage the LCD display, interrupt running programs, cause data loss in memory and result in malfunction.
4. Do not tap the touch screen with sharp objects. Doing so may damage the screen or cause internal short circuits.
5. Do not press against or strike the LCD screen. Otherwise it may damage the screen. When handling a cracked or shattered screen, do not touch the liquid that has leaked from it to avoid skin burn or infection.
6. Do not expose the device to direct sunlight for extended periods.
7. Sudden temperature drops may cause condensation on the shell which could cause malfunction. If condensation occurs, dry the terminal before use.

Appendix

Sample Barcodes

Code 128



UCC/EAN-128



UPC-E



UPC-A



Interleaved 2 of 5



Code 39



PDF 417



QR Code



Micro QR



Data Matrix



Chinese Sensible Code



Code ID Table

Symbology	Code ID
Code 128	#
EAN128	P
AIM128	a
EAN-8	FF
EAN-13	F
UPC-E	b
UPC-A	d
ISBN	e
ISSN	g
Code 39	*
Code 93	c
Codabar	%
Interleaved 2 of 5	i
Deutsche 14 (Deutsche Post Leitcode)	h
Deutsche 12 (Deutsche Post Identcode)	j
Standard 25	k
Matrix 2 of 5	l
Industrial 25	m
Code 11	n
MSI-Plessey	o
Plessey	q
GS1 Codabar (RSS)	R
CODE32	t
PDF417	r
QR Code	s
Aztec	z
Data Matrix	u
EAN413	v
EAN414	w
EAN419	x



Newland

SCANNING MADE SIMPLE

Newland EMEA HQ
+31 (0) 345 87 00 33
info@newland-id.com
newland-id.com

Need more info? Contact us or one of
our partners at newland-id.com/partners